

SIEMENS



LMV27.100x2

Basic unit with integrated air-fuel ratio control for forced draft burners

Basic Documentation

The LMV27 and this Basic Documentation are intended for OEMs which integrate the units in their products!

Software version
V03.70

CC1P7541en
17.12.2018

Building Technologies

Supplementary documentation

User Documentation Modbus AZL2.....	A7541
Environmental Product Declaration LMV2 / LMV3.....	E7541
Installation and Operating Instructions PC Software ACS410	J7352
Data Sheet LMV27.....	N7541
Product Range Overview LMV2 / LMV3	Q7541

Contents

1	Safety notes	9
1.1	Warning notes	9
1.2	Mounting notes	10
1.3	Installation notes.....	11
1.4	Electrical connection of the LMV27	12
1.5	Connection BCI via integrated RJ11 jack (X56)	13
1.6	Electrical connection of flame detectors	14
1.7	Commissioning notes	15
1.8	Notes on settings and parameter settings	17
1.9	Standards and certificates	18
1.10	Service notes	19
1.11	Life cycle.....	19
1.12	Disposal notes	19
2	System structure / function description	20
2.1	For Europe.....	20
2.2	General information	21
3	Type summary	21
4	Technical Data	22
4.1	LMV27 basic unit.....	22
4.1.1	Terminal loading <i>Inputs</i>	22
4.1.2	Terminal loading <i>Outputs</i>	23
4.1.3	Analog output / load output X74 pin 3	23
4.1.4	Cable lengths.....	24
4.1.5	Cross-sectional areas.....	24
4.1.6	Connections of actuators.....	24
4.2	AGV50 signal cable from AZL2 → BCI.....	25
4.3	Environmental conditions	25
4.4	Flame detectors.....	26
4.4.1	Ionization probe	26
4.4.2	UV flame detectors QRA2 / QRA4 / QRA10.....	28
4.4.3	Photoresistive flame detectors QRB1 / QRB3.....	29
4.4.4	Yellow flame detector QRB4	30
4.4.5	Blue-flame detectors QRC.....	31
5	Dimensions	32
5.1	LMV27	32
6	Display and diagnostics	33
7	Basic unit LMV27	33
7.1	Description of inputs and outputs	33
7.2	Flame detectors.....	34
7.2.1	Loss of flame	34
7.2.2	Extraneous light.....	35
7.2.3	No flame at the end of safety time (TSA)	35
7.2.4	Flame intensity	35
7.2.5	Supervision of flame detector	35

7.3	Digital input	36
7.3.1	Safety loop X3–04, pin 1 and 2.....	36
7.3.2	Burner flange X3–03, pin 1 and 2	37
7.3.3	Input for external load controller (ON / OFF) X5–03, pin 1	37
7.3.4	Inputs X5–03 pin 2 and 3 (Opening / Closing or stage 2 / stage 3)	37
7.3.5	Air pressure switch X3–02	38
7.3.6	Gas pressure switch for valve proving X9-04	39
7.3.7	Gas / oil pressure switch-min, start release gas X5-01.....	40
7.3.8	Setting the time for making the pressure switch test	42
7.3.9	Gas / oil pressure switch-max / oil pressure-max or POC contact, start release oil X5–02	43
7.3.10	Reset X8-04, pin 1	44
7.4	Digital outputs	45
7.4.1	Output alarm type No-SI – X3–05, pin 2	45
7.4.2	Fan motor contactor type SI – X3–05, pin 1	45
7.4.3	Continuous fan operation – X3–05, pin 3.....	45
7.4.4	Output ignition type SI (IGNITION) – X4–02.....	46
7.4.5	Outputs fuel valves V1 / V2 / V3 / PV, type SI – X8–02, X7-01, X7-02.....	47
7.4.6	Output safety valve type SI – X6–03.....	47
7.4.7	Output for indication of operation X8-04, pin 2	47
7.5	Program sequence.....	48
7.5.1	Time parameters.....	48
7.5.2	Valve proving	49
7.5.2.1.	Valve proving with separate pressure switch X9-04	50
7.5.2.2.	Valve proving via gas pressure switch-min X5-01	51
7.5.2.3.	Lockout phase (phase 00)	51
7.5.2.4.	Safety phase (phase 01).....	52
7.5.3	Special functions during the program sequence.....	53
7.5.3.1.	Reset / manual lockout	53
7.5.3.2.	Alarm upon start prevention.....	54
7.5.3.3.	Possible start preventions.....	54
7.5.3.4.	Repetition counter.....	55
7.5.3.5.	Start without prepurging (as per EN 676)	57
7.5.3.6.	Gas shortage program	58
7.5.3.7.	Program stop function.....	59
7.5.3.8.	Forced intermittent operation (<24 hours)	59
7.5.3.9.	Low-fire shutdown.....	59
7.5.3.10.	Continuous fan.....	60
7.5.3.11.	Test function for approval of burner – loss-of-flame test (TÜV test)	61
7.5.3.12.	Postpurging in the lockout position	62
7.6	Fuel trains (application examples)	63
7.7	Sequence diagrams	71
7.7.1	Gas direct ignition «G», «G mod», «G mod pneu».....	71
7.7.2	Gas pilot ignition 1 «Gp1», «Gp1 mod», «Gp1 mod pneu»	72
7.7.3	Gas pilot ignition 2 «Gp2», «Gp2 mod», «Gp2 mod pneu»	73
7.7.4	Light oil direct ignition «Lo», «Lo mod», «Lo 2 stage», « Lo 3-stage».....	74
7.7.5	Light oil – pilot ignition «LoGp»«LoGp mod» «LoGp 2-stage»	75
7.7.6	Legend to the sequence diagrams.....	76
8	Selection of operating mode.....	79

8.1	Deleting curves.....	81
9	Connection to load controllers	82
9.1	Load controller on contact X5-03, pin 1.....	82
9.2	External load controller via contacts X5-03, pin 2 / pin 3.....	82
9.3	Default output via building automation – X92.....	85
9.4	Manual output.....	86
9.5	Output with curve settings	86
9.6	Prioritization of load controller sources.....	87
9.6.1	Emergency operation with several load controller sources	87
9.6.2	Manual control.....	87
10	Electronic air-fuel ratio control	89
10.1	General.....	89
10.2	Behavior outside the operating positions.....	89
10.2.1	Traveling speed.....	89
10.2.2	Home position.....	89
10.2.3	Prepurging.....	89
10.2.4	Ignition.....	90
10.2.5	Postpurging	90
10.3	Modulating operation.....	91
10.3.1	Definition of curves	91
10.3.2	Traveling speed/maximum curve slope.....	92
10.3.3	Entering the running position.....	92
10.3.4	Operating position	92
10.3.5	Limitation of modulation range	93
10.3.6	Setting the minimum and maximum output	94
10.4	Multistage operation	95
10.4.1	Definition of curves.....	95
10.4.2	Traveling speed.....	95
10.4.3	Adjustment of output.....	96
10.4.4	Entering the operating position.....	96
10.4.5	Operating position	96
10.4.6	Limitation of modulation range	97
10.5	End of operating position.....	97
10.6	Notes on settings and parameter settings.....	97
11	Actuators X53 / X54	98
11.1	Function principle	98
11.2	Definition of angles.....	98
11.3	Referencing	99
11.3.1	Reference travel.....	101
11.4	Direction of rotation	103
11.5	Monitoring the actuator positions.....	104
11.6	Changing the error detection band for monitoring the actuator positions	105
11.7	Forced travel.....	105
11.8	Detection of line interruptions.....	105
11.9	Protection against actuator mixup	106
11.9.1	Proposal for implementation.....	106

12	Load output X74 pin 3	107
12.1	Safe separation of mains voltage and extra low-voltage	107
12.2	Modulating operation	108
12.3	2-stage operation	108
12.4	3-stage operation	108
13	Fuel meter input X75 pin 1 / X75 pin 2	109
13.1	Configuration of fuel meter.....	109
13.1.1	Types of fuel meters	109
13.1.2	Configuration of pulses per volume unit.....	109
13.1.3	Reading and resetting the meter readings.....	109
13.2	Fuel throughput.....	110
13.2.1	Configuration.....	110
13.2.2	Reading out the fuel throughput.....	110
14	Connection and internal diagram.....	111
15	Special feature: Burner identification.....	112
16	Connection to superposed systems	112
16.1	General information and building automation functions.....	112
16.2	Modbus	113
17	PC software ACS410.....	114
18	Error history	115
18.1	Error classes	115
18.2	Makeup of error history	116
19	Lifecycle function	117
20	Safety notes on use of the AZL2	117
21	Operating via AZL2 unit	118
21.1	Description of unit / display and buttons	118
21.2	Meaning of symbols on the display.....	119
21.3	Brightness of display.....	119
21.4	Special functions.....	120
21.4.1	Manual lockout.....	120
21.4.2	Manual control (manual request for output).....	121
21.5	Timeout for menu operation.....	122
21.6	Backup / restore.....	122
21.6.1	Backup	123
21.6.2	Restore	125
22	Operation of LMV27 via the AZL2.....	127
22.1	Normal display	127
22.1.1	Display in standby mode.....	127
22.1.2	Display during startup / shutdown.....	127
22.1.2.1.	Display of program phases	127
22.1.2.2.	Display of program phase with remaining running time until end of the phase is reached.....	127
22.1.2.3.	List of phase displays.....	128
22.1.3	Display of operating position.....	129
22.1.4	Fault status message, display of errors and info	130

22.1.4.1.	Display of errors (faults) with lockout.....	130
22.1.4.2.	Reset'	130
22.1.4.3.	Activating info / service mode from lockout	130
22.1.4.4.	Error with safety shutdown	131
22.1.4.5.	General information	131
22.1.4.6.	Start prevention	131
22.1.4.7.	Safety loop.....	131
23	Menu-driven operation	132
23.1	Assignment of levels.....	132
24	Info level	133
24.1	Display of info level.....	133
24.2	Display of info values (examples).....	134
24.2.1	Identification date	134
24.2.2	Identification number	134
24.2.3	Burner identification.....	135
24.2.4	Number of startups resettable	136
24.2.5	Total number of startups.....	137
24.2.6	End of info level.....	137
25	Service level.....	138
25.1	Display of service level	138
25.2	Display of service values (example).....	139
25.2.1	Number of faults	139
25.2.2	Error history	139
25.2.3	Intensity of flame	139
25.2.4	End of service level	139
26	Parameter level.....	140
26.1	Entry of password.....	141
26.2	Entry of burner identification	143
26.3	Change of heating engineer's password	145
26.4	Change of OEM's password.....	146
26.5	Use of parameter level	147
26.6	Structure of parameter levels	148
26.7	Parameters without index, with direct display.....	149
26.7.1	Using the example of parameter 208: Program stop.....	149
26.8	Parameters without index, with no direct display (with parameters having a value range > 5 digits)	151
26.8.1	Using the example of parameter 162: Operating hours resettable	151
26.9	Parameter with index, with direct display	153
26.9.1	Using the example of parameter 501: No-flame positions fuel actuator	153
26.10	Parameters with index, with no direct display.....	155
26.10.1	Using the example of parameter 701: Errors.....	155
26.11	Fuel / air ratio curves – settings and commissioning.....	158
26.11.1	Initial commissioning	158
26.11.2	Setting curvepoints P0 and P9 for modulating mode («G mod», «Gp1 mod», «Gp2 mod» and «Lo mod»).....	161
26.11.3	Setting curvepoints P0 and P9 for «G mod pneu», «Gp1 mod pneu» and «Gp2 mod pneu».....	162

26.11.4	Warm settings for modulating mode («G mod», «Gp1 mod», «Gp2 mod» and «Lo mod»)	163
26.11.5	Warm settings for modulating mode («G mod pneu», «Gp1 mod pneu» and «Gp2 mod pneu»)	168
26.11.6	Cold settings for «G mod», «Gp1 mod», «Gp2 mod» and «Lo mod»	168
26.11.7	Cold settings for «G mod pneu», «Gp1 mod pneu» and «Gp2 mod pneu»	169
26.11.8	Editing the curvepoints	170
26.11.9	Interpolation of curvepoints	171
26.11.10	Setting of curvepoints for multistage mode («Lo 2 stage» and «Lo 3 stage»)	174
26.11.11	Warm settings for «Lo 2 stage» and «Lo 3 stage»	175
26.11.12	Cold settings for multistage mode («Lo 2 stage» and «Lo 3 stage»)	179
26.11.13	Intensity of flame during curve settings	180
27	Parameter list	181
28	Error code list (of all LMV2 / LMV3 types)	193
29	Revision history LMV27	210
30	List of figures	217

1 Safety notes

1.1 Warning notes



To avoid injury to persons, damage to property or the environment, the following warning notes must be observed!

LMV27 are safety devices! Do not open, interfere with or modify the units. Siemens does not assume responsibility for damage resulting from unauthorized interference!

Additional safety notes contained in other chapters of this document must be observed as well!

After commissioning and after each service visit, check the flue gas values across the entire output range!

The present Basic Documentation describes a wide choice of applications and functions and shall serve as a guideline. The correct functioning of the units is to be checked and proven by function checks on a test rig or on the plant itself!

- All activities (mounting, installation and service work, etc.) must be performed by qualified personnel
- Degree of protection IP40 as per DIN EN 60529 for the LMV27 must be ensured through adequate mounting by the burner or boiler manufacturer
- Before performing any work in the connection area of the plant, disconnect the unit from the mains supply (all-polar disconnection). Ensure that the plant cannot be inadvertently switched on again and that it is indeed dead. If not disconnected, there is a risk of electric shock hazard
- Protection against electric shock hazard on the LMV27 and on all connected electrical components must be ensured through adequate mounting. In terms of design, stability and protection, the cover used must conform to EN 60730
- After each activity (mounting, installation and service work, etc.), check to ensure that wiring is in an orderly state and that the parameters are correctly set
- Fall or shock can adversely affect the safety functions. Such units must not be put into operation even if they do not exhibit any damage
- When programming the air-fuel ratio control curves, the commissioning engineer must constantly watch the quality of the combustion process (e.g. by means of a flue gas analyzer) and, in the event of poor combustion values or dangerous conditions, take appropriate actions, e.g. by shutting down the LMV27 manually
- The following plug-on terminations carry FELV (Functional Extra Low Voltage) (also refer to chapter *Electrical connection of the LMV27*) which means that they do not provide safe separation from mains voltage:
 - The BCI (X56) for the connecting cable of the AZL2 or PC software ACS410
 - COM (X92) for accessories, such as the OCI410These plug-on terminations may be removed or replaced only when the plant is dead (all-polar disconnection)
- The plugs of the connecting cables for the LMV27 or other accessories, such as the OCI410 (plugged into the BCI), may only be removed or exchanged when the plant is shut down (all-polar disconnection), since the BCI does not provide safe separation from mains voltage
- The connections for the SQM3 or SQN1 actuators do not provide safe separation from mains voltage. Prior to connecting or changing one of these actuators, the plant must be shut down (all-polar disconnection)

To ensure safety and reliability of the LMV27, the following points must also be observed:

- Condensation and ingress of humidity must be avoided. Should such conditions occur, make sure that the unit will be completely dry before switching on again!
- Static charges must be avoided since they can damage the unit's electronic components when touched.

Recommendation: Use ESD equipment

- If the unit fuse was blown due to overload or a short-circuit at the connection terminals, the LMV27 must be replaced since the switching contacts might have been damaged
- If error codes 95...98 appear during operation, this may be an indication of contact problems and the LMV27 should be replaced

1.2 Mounting notes

- Ensure that the relevant national safety regulations and standard notes are complied with
- In geographical areas where DIN regulations are in use, the requirements of VDE must be satisfied, especially DIN / VDE 0100, 0550 and DIN / VDE 0722
- The LMV27 must be secured with fixing screws M4 (UNC32) or M5 (UNC24), observing a maximum tightening torque of 1.8 Nm and using all 4 fixing points. The additional mounting surfaces on the housing are provided to improve mechanical stability. These must fully rest on the mounting surface to which the unit is secured. The flatness of that mounting surface must be within a tolerance band of 0.3 mm

Notes on mounting

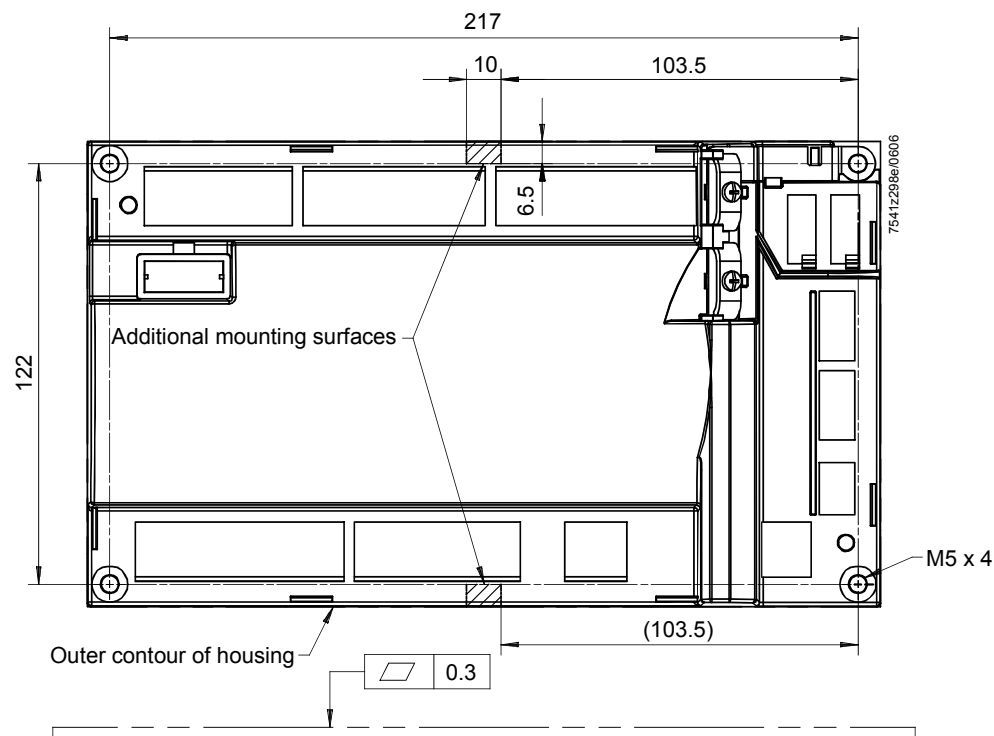

Figure 1: Note on mounting

1.3 Installation notes

- Always run the high-voltage ignition cables separate from the unit and other cables while observing the greatest possible distances
- Ensure that the electrical wiring inside the boiler is in compliance with national and local safety regulations
- Mains power must always be supplied via *L* and *N*.
This means that no potential differential must exist between the neutral conductor *N* and protective conductor *PE*
- Phase and neutral conductor must not be interchanged (dangerous malfunctions, loss of protection against electric shock hazard, etc.)
- Make certain that strain relief of the connected cables is in compliance with the relevant standards (e.g. as per DIN EN 60730 and DIN EN 60335)
- Ensure that spliced wires cannot get into contact with neighboring terminals. Use adequate ferrules
- The burner manufacturer must protect unused terminals of the LMV27 by fitting dummy plugs (exception: X64 (reserve) and X74)
- When making the wiring, the AC 230 V section must be strictly separated from other voltage sections, thus ensuring protection against electric shock hazard. For more detailed information, refer to chapter *Electrical connection of the LMV27*
- The connectors of the connecting cables for the LMV27 may only be removed or exchanged when the plant is turned off (all-polar disconnection), since the BCI does not provide safe separation from mains voltage
- AGV50 signal cable between LMV27 and AZL2
Since the BCI carries FELV (refer to chapter *Electrical connection of the LMV27*), the connection between LMV27 and AZL2 must be established via the AGV50 signal cable, or by ensuring compliance with the specification. The signal cable is specified for use under the burner hood. When using other types of signal cable that do not meet the specification requirements, safety against electric shock hazard is not necessarily ensured
- Do not lay signal cable AGV50 from the LMV27 to the AZL2 together with other cables
- Service operation with a longer signal cable from the LMV27:
If a longer signal cable is required for service work for example (short-time usage, <24 hours), note that the above application under the burner hood no longer applies and, for this reason, the signal cable can be subjected to increased mechanical stress. In that case, use a reinforced signal cable
- Both the signal cable AGV50 and the AZL2 must be shipped and stored so that no damage due to dust and water can occur when the products are used in the plant
- To ensure protection against electric shock hazard, make certain that, prior to switching on power, the signal cable AGV50 is correctly connected to the AZL2
- The AZL2 must be used in a dry and clean environment
- The mechanical coupling between the actuators and the controlling elements for fuel and air, or any other controlling elements, must be rigid
- Once the LMV27 has been installed in the equipment, a check must be carried out to ensure compliance with the EMC emission requirements!
- When grounded PELV signals are connected to the SELV terminals of the burner control, they also become PELV voltages (according to EN 60730-1, chapter 11.2.7, EN 298 chapter 9.2.d)
- An isolating transformer grounded on one side must be used if the wiring takes place with a mains circuit without a grounded conductor or the mains supply between the phases (in accordance with EN 298-1, chapter 9.2.d)
- To prevent high-energy couplings due to magnetic induction or capacitive coupling, the cable lengths must be >10 m on the detector cables and communication lines with a shielded cable, grounded on both sides (based on requirements from EN 13611)
- Testing torque of the screws RAST5 connector: 0.5 Nm
- Testing torque of the screws RAST3.5 connector: 0.25 Nm

1.4 Electrical connection of the LMV27

The LMV27 operates with the following low-voltages:

- SELV (Safety Extra Low-Voltage) and PELV (Protective Extra Low-Voltage) ensure protection against electric shock hazard
- FELV (Functional Extra Low-Voltage) without safe separation offers no protection which, in the event of fault, would not exclude risks

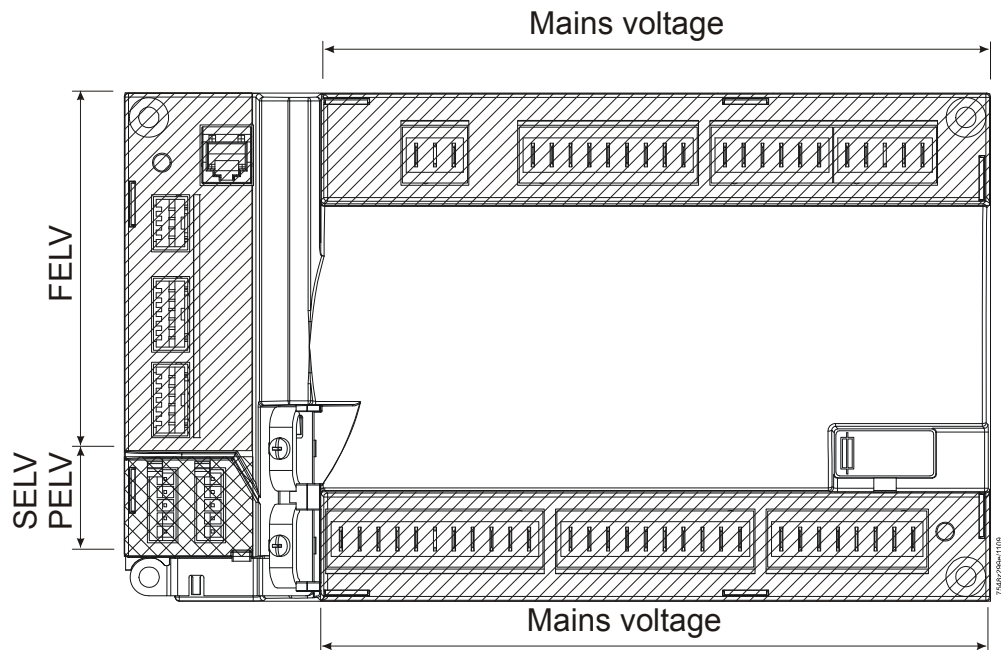

Figure 2: Electrical connection



Note

SELV or PELV depends on the safety class of the connected components. In the case of PELV, the relevant component is connected to protective earth.

1.5 Connection BCI via integrated RJ11 jack (X56)

- If the BCI (RJ11 jack) is not used, protection against electric shock hazard must be provided (jack must be covered up)
- The signal cable for the AZL2 or other accessories, such as the OCI410 interface (plugs into the RJ11 jack), may be connected or disconnected only when the LMV27 is dead (all-polar disconnection), since the BCI does not ensure safe separation from mains voltage
- The AZL2 is designed for direct connection to the integrated RJ11 jack at the LMV27
- The signal cable from the LMV27 to the AZL2 must conform to certain specifications. Siemens has specified the signal cable for use under the burner hood. When using signal cables of other manufacture, Siemens requirements are not necessarily met
- Do not lay the signal cable from the LMV27 to the AZL2 together with other cables. Use a separate cable
- Service operation with a longer signal cable from the LMV27 to AZL2
If a longer cable is required for service work for example (short-time usage, <24 hours), note that the above application under the burner hood no longer applies and, for this reason, the cable may be subjected to increased mechanical stress. In that case, use a reinforced cable
- Both the signal cable and the AZL2 must be shipped and stored in a way that no damage due to dust and water can occur when the products are used in the plant
- To ensure protection against electric shock hazard, make certain that, prior to applying power, the signal cable is correctly connected to the AZL2
- The AZL2 must be used in a dry and clean environment

Connection of OCI410 interface to the BCI

Connect the OCI410 interface without other extension to the USB port of your PC according to the example given below.

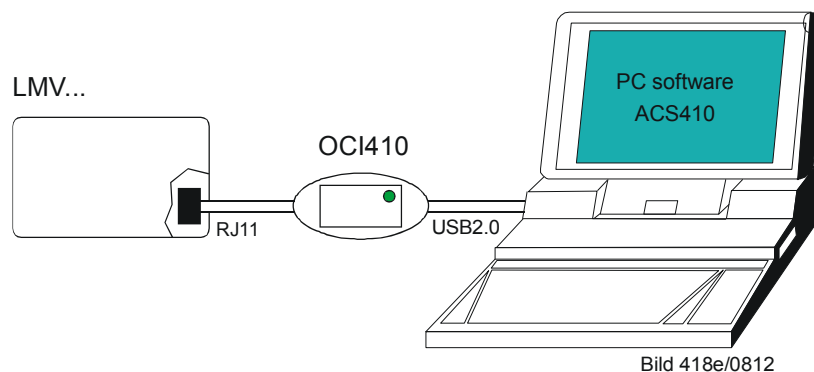

Figure 3: Connection of OCI410 interface to the BCI

1.6 Electrical connection of flame detectors

It is important to achieve practically disturbance- and loss-free signal transmission:

- Never run the detector cables together with other cables
 - Line capacitance reduces the magnitude of the flame signal
 - Use a separate cable
- Observe the permissible detector cable lengths
- The mains-powered ionization probe is not protected against electric shock hazard. It must be protected against accidental contact
- Earth the burner in compliance with the relevant regulations; earthing the boiler alone does not suffice
- Locate the ignition electrode and the ionization probe such that the ignition spark cannot arc over to the ionization probe (risk of electrical overloads)
- Insulation resistance
 - Must be a minimum of 50 M Ω between ionization probe and ground
 - Soiled detector holders reduce the insulation resistance, thus supporting creepage currents

1.7 Commissioning notes

- When commissioning the unit, check **all safety functions**
- There is no absolute protection against incorrect use of the RASTx connectors. For this reason, prior to commissioning the plant, check the correct assignment of all connectors
- Electromagnetic emissions must be checked on an application-specific basis

After the plant has been installed and commissioned, the person responsible for the plant / heating engineer must **document** the parameterized values and settings (e.g. curve characteristics) used for air-fuel ratio control.

These data can be printed out with the help of the ACS410 PC software, for example, or must be written down.

This document must be kept in a safe place and checked by the expert.



Caution!

On the OEM level of the LMV27, parameter settings other than those specified in the application standards can be made. For this reason, check whether the parameter settings made are in compliance with the relevant application standards (e.g. EN 676, EN 267, etc.), or whether the respective plant demands special approval!

Fuel / air ratio control system

The selected setting values of fuel and combustion air must be assigned such that – while giving consideration to the combustion chamber / fuel pressure, temperature and combustion air pressure, as well as wear of actuators and controlling elements, etc. – correct operation with sufficient amounts of excess air will be ensured across the burner's full output range for an extensive period of time (until the next regular inspection is due; also refer to chapter *Monitoring the positions*). This must be proven by the burner / boiler manufacturer by measuring the characteristic combustion process values. If the standardization process is repeated, the air-fuel ratio control system must be rechecked.

LMV27

Prior to commissioning the system, the following points must be checked:

- Parameterization of operating mode (e.g. «G mod», «Gp1 mod», «Lo mod», etc.) must accord with the type of burner used (refer to chapter *Selection of operating mode*)
- Correct assignment of the valves to the valve outputs of the LMV27
- Correct setting of the time parameters, especially the safety and prepurge times
- Correct functioning of the flame detector in the event of loss of flame during operation (including the response time), with extraneous light, during the prepurge time and, when there is no establishment of flame, at the end of the ignition safety time
- Activation of the valve proving function and determination of the correct leakage rate, if required by the application (refer to chapter *Valve proving*)

The functions of the following available or required input status signals must be checked:

- Air pressure
- Minimum gas pressure and maximum gas pressure or POC
- Gas pressure valve proving
- Minimum oil pressure and maximum oil pressure
- Safety loop (e.g. safety limiter)

Duties of the expert when making the approval tests

	Action	Check / response
a)	Burner startup with flame detector darkened	Lockout at the end of the first safety time
b)	Burner startup with flame detector exposed to extraneous light, e.g. to incandescent light with detectors for visible radiation, quartz-halogen bulb or cigarette lighter flame with detectors for UV radiation	Lockout at prepurge time
c)	Simulation of loss of flame during operation. For that, darken the flame detector in the operating position and maintain that state	Lockout or restart, depending on the LMV27's configuration
d)	Check the plant's response time with loss of flame during operation. For that purpose, manually disconnect the fuel valves from power and check the time from this moment the LMV27 requires to turn off power to the valve	Turning off power to the valves by the LMV27 within the period of time permitted for the respective type of plant
e)	Check the safe operation of the burner while giving consideration to LMV27 tolerances	<p>LMV27 tolerances are the result of a number of factors, such as:</p> <ul style="list-style-type: none"> • Tolerances of actuators plus mechanical linkage to the controlling elements • Environmental conditions (temperature, air conditions) • Type of fuel (calorific value / pressure) • Type of supply air path and flueways <p>Example of procedure for checking the burner's response to actuator tolerances:</p> <ul style="list-style-type: none"> • Approach a output point in programming mode (e.g. low-fire or high-fire) • Change the actuator's position against the optimum fuel-air ratio setting as can be expected in the case of tolerances • Check the flue gas values with a flue gas analyzer <p>Recommendation: Make this readjustment against the optimum fuel-air ratio setting for one actuator at a time!</p>

Further checks may be required, depending on the field of use and the relevant standards.

1.8 Notes on settings and parameter settings

- When adjusting the electronic air-fuel ratio control system integrated in the LMV27, allow for sufficient amounts of excess air since – over a period of time – the flue gas settings are affected by a number of factors (e.g. density of air, wear of actuators and controlling elements, etc.). For this reason, the flue gas values initially set must be checked at regular intervals
- To safeguard against inadvertent or unauthorized parameter transfer from the ACS410 PC software to the LMV27, the OEM must assign an **individual burner identification** (ID) for each burner. Compliance with this regulation is mandatory to ensure that the LMV27 prevents the transfer of parameter sets of some other plant (with inadequate and possibly dangerous parameter values) to the LMV27 via the ACS410 PC software. In addition, the air-fuel ratio control parameters must be manually approached and the combustion values checked
- With the LMV27, it is to be noted that the unit's characteristics are determined primarily by the specific parameter settings rather than the type of LMV27. This means that, among other things, each time a plant is commissioned, the parameter settings must be checked and the LMV27 must not be transferred from one plant to another without adapting the parameter settings to the new plant
- When using the ACS410 PC software, the safety notes given in the relevant Installation and Operating Instructions (J7352) must also be observed
- A password protects the parameter level against unauthorized access. The OEM allocates individual passwords to the setting levels he can access. The default passwords used by Siemens must be changed by the OEM. These passwords are confidential and may only be given to persons authorized to access such setting levels
- The responsibility for setting the parameters lies with the person who – in accordance with his access rights – made changes to the respective setting level

In particular, the OEM (burner and / or boiler manufacturer) assumes responsibility for the correct parameter settings in compliance with the standards covering the specific applications (e.g. EN 676, EN 267, EN 746-2, etc.).

1.9 Standards and certificates



Applied directives:

- Low-voltage directive 2014/35/EC
- Directive for pressure devices 2014/68/EC
- Gas Appliances Regulation (EU) EU/2016/426
- Electromagnetic compatibility EMC (immunity) *) 2014/30/EC

*) The compliance with EMC emission requirements must be checked after the burner management system is installed in equipment

Compliance with the regulations of the applied directives is verified by the adherence to the following standards / regulations:

- Automatic burner control systems for burners and appliances burning gaseous or liquid fuels DIN EN 298
- Safety and control devices for gas burners and gas burning appliances - Valve proving systems for automatic shut-off valves DIN EN 1643
- Gas/air ratio controls for gas burners and gas burning appliances - Part 2: Electronic types DIN EN 12067-2
- Safety and control devices for burners and appliances burning gaseous and/or liquid fuels — General requirements DIN EN 13611
- Safety and control devices for gas burners and gas-burning appliances - Particular requirements Part 1: Automatic and semi-automatic valves ISO 23552-1
- Automatic electrical controls for household and similar use Part 2-5: Particular requirements for automatic electrical burner control systems DIN EN 60730-2-5

The relevant valid edition of the standards can be found in the declaration of conformity!



Note on **DIN EN 60335-2-102**

Household and similar electrical appliances - Safety - Part 2-102:

Particular requirements for gas, oil and solid-fuel burning appliances having electrical connections. The electrical connections of the LMV27 comply with the requirements of EN 60335-2-102.



EAC Conformity mark (Eurasian Conformity mark)



ISO 9001:2015
ISO 14001:2015
OHSAS 18001:2007



China RoHS
Hazardous substances table:
<http://www.siemens.com/download?A6V10883536>



1.10 Service notes

- **If fuses are blown, the unit must be returned to Siemens** (refer to chapter *Warning notes*)
- Error diagnostics can only be made via the LMV27 (BC interface)



Note!

Only authorized persons may replace the fuse (according to EN 298-1, chapter 9.2.r)

1.11 Life cycle

The burner management system has a designed lifetime* of 250,000 burner startup cycles which, under normal operating conditions in heating mode, correspond to approx. 10 years of usage (starting from the production date given on the type field). This lifetime is based on the endurance tests specified in standard EN 298. A summary of the conditions has been published by the European Control Manufacturers Association (Afecor) (www.afecor.org).

The designed lifetime is based on use of the LMV27 according to the manufacturer's Data Sheet and Basic Documentation. After reaching the designed lifetime in terms of the number of burner startup cycles, or the respective time of usage, the LMV27 is to be replaced by authorized personnel.

* The designed lifetime is not the warranty time specified in the Terms of Delivery

1.12 Disposal notes

The unit contains electrical and electronic components and must not be disposed of together with household waste. Local and currently valid legislation must be observed.

2 System structure / function description

The LMV27 is a microprocessor-based burner management system with matching system components for the control and supervision of forced draft burners of medium to high capacity.

In the LMV27 are integrated:

- Burner management system complete with valve proving system
- Electronic air-fuel ratio control system for a maximum of 2 SQM3 or SQN1 actuators
- Modbus interface

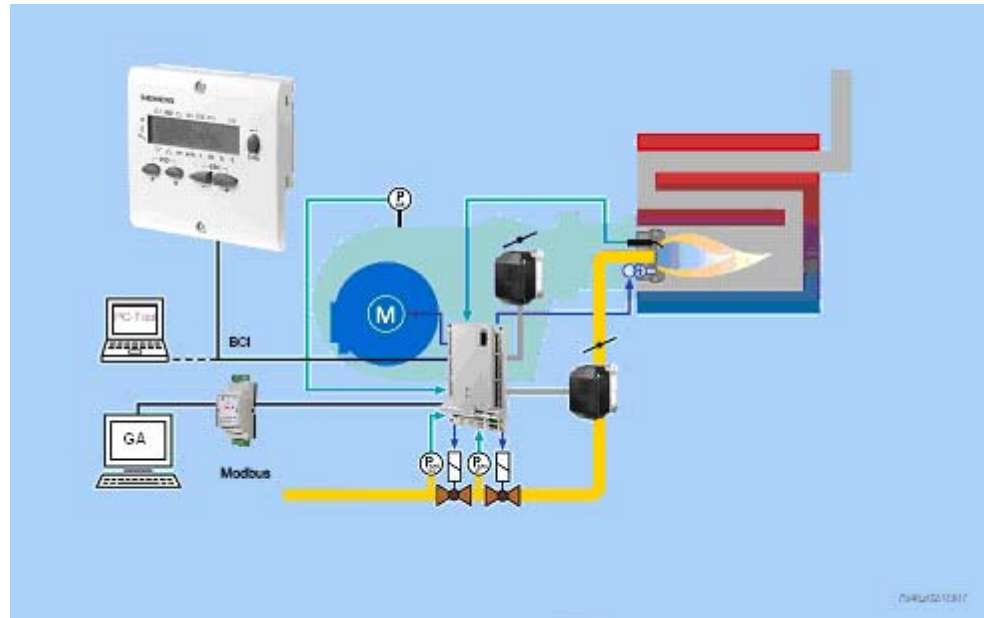

Figure 4: System structure

Example: Modulating gas burner

The system components (AZL2, actuators) are connected directly to the LMV27. All safety-related digital inputs and outputs of the LMV27 are monitored by a contact feedback network.

The diagram shows the full scope of functions of the LMV27. The actual functions are to be determined based on the respective execution / configuration!

2.1 For Europe

For intermittent operation in connection with the LMV27, the ionization probe or the QRA, QRB or QRC optical flame detectors can be used.

2.2 General information

The burner management system is operated and parameterized either via the AZL2 or with the help of the ACS410 PC software. The AZL2 with LCD and menu-driven operation facilitates straightforward use and targeted diagnostics. When making diagnostics, the display shows the operating states, the type of error and the point in time the error occurred. Passwords protect the different parameter levels of the burner / boiler manufacturer and heating engineer against unauthorized access. There is also a COM port which can be accessed from a superposed system, such as a building automation and control system (BACS).

On the BCI interface via interface OCI410, a PC can be connected with the PC software ACS410 (for dual fuel operation → on request).

Among other features, the ACS410 software affords convenient readout of settings and operating states, parameterization of the LMV27, and trend recordings. The burner / boiler manufacturer can select from different types of fuel trains and make use of a wide choice of individual parameter settings (program times, configuration of inputs / outputs, etc.), enabling him to make optimum adaptations to the relevant application. The actuators are driven by stepper motors and can be positioned with high resolution. Specific features and actuator settings are defined by the LMV27.

3 Type summary

Microprocessor-based LMV27 for single-fuel burners of any capacity, for intermittent operation, with electronic air-fuel ratio control, up to 2 actuators and with integrated gas valve proving system.

Article no.	Type	Mains voltage	Parameter set	Flame detectors	TSA	
					Gas	Oil
BPZ:LMV27.100A2	LMV27.100A2	AC 230 V	Europe	QRA2 / QRA4 / QRA10 / QRB / QRC / ION	3 s	5 s

4 Technical Data

4.1 LMV27 basic unit

Mains voltage	AC 230 V -15 % / +10 %
Mains frequency	50 / 60 Hz \pm 6 %
Power consumption	<30 W (typically)
Safety class	I with parts according to II and III to DIN EN 60730-1
Degree of protection	IP00 to DIN EN 60529



Note

The burner or boiler manufacturer must ensure degree of protection IP40 for the LMV27 as per DIN EN 60529 through adequate installation

Mode of operation	Type 2B in accordance with DIN EN 60730-1
Rated surge voltage	In accordance with DIN EN 60730-1 chapter 20 (OC III)
Voltage and current for the purposes of the EMC emitted interference tests	The emitted interference measurement test takes place with mains voltage and maximum power consumption

4.1.1 Terminal loading *Inputs*

• Perm. mains primary fuse (externally)	Max. 16 AT
• Unit fuse F1 (internally)	6.3 AT (DIN EN 60127 2 / 5)
• Mains supply: Input current depending on the operating state of the unit	
Undervoltage	
• Safety shutdown from operating position at mains voltage	Approx. AC 186 V
• Restart on rise in mains voltage	Approx. AC 195 V
Status inputs: Status inputs (with the exception of the safety loop) of the contact feedback network (CFN) are used for system supervision and require mains-related input voltage	
• Input safety loop	Refer to <i>Terminal loading outputs</i>
• Input currents and input voltages	
- UeMax	UN +10 %
- UeMin	UN -15 %
- IeMax	1.5 mA peak
- IeMin	0.7 mA peak
• Contact material recommendation for external signal sources (air pressure switch, pressure switch-min, pressure switch-max, etc.)	Gold-plated silver contacts
• Transition / settling behavior / bounce	
- Perm. bounce time of contacts when switching on / off	Max. 50 ms (after the bounce time, contact must stay closed or open)
• UN	AC 230 V
• Voltage detection	
- On	AC 180...253 V
- Off	<AC 80 V

4.1.2 Terminal loading *Outputs*

Total contact loading:

• Rated voltage	AC 230 V, 50 / 60 Hz
• Unit input current (safety loop) from:	Max. 5 A
- Fan motor contactor	
- Ignition transformer	
- Valves	
- Oil pump / magnetic clutch	

Individual contact loading:

Fan motor contactor

• Rated voltage	AC 230 V, 50 / 60 Hz
• Rated current	2 A
• Power factor	$\text{Cos}\varphi > 0.4$

Alarm output

• Rated voltage	AC 230 V, 50 / 60 Hz
• Rated current	1 A
• Power factor	$\text{Cos}\varphi > 0.4$

Ignition transformer

• Rated voltage	AC 230 V, 50 / 60 Hz
• Rated current	2 A
• Power factor	$\text{Cos}\varphi > 0.2$

Fuel valves

• Rated voltage	AC 230 V, 50 / 60 Hz
• Rated current	2 A
• Power factor	$\text{Cos}\varphi > 0.4$

Operation display

• Rated voltage	AC 230 V, 50 / 60 Hz
• Rated current	0.5 A
• Power factor	$\text{Cos}\varphi > 0.4$

Safety valve (magnetic clutch / oil pump)

• Rated voltage	AC 230 V, 50 / 60 Hz
• Rated current	2 A
• Power factor	$\text{Cos}\varphi > 0.4$

Connections for pressure switch

• Rated voltage	AC 230 V, 50 / 60 Hz
• Rated current	1.5 mA
• Power factor	---

Power supply for pressure switch-max / POC (X5-02 pin 3)

• I_{aMax}	<10 mA
---------------------	--------

4.1.3 Analog output / load output X74 pin 3

Accuracy of output voltage	$\pm 1\%$
----------------------------	-----------

4.1.4 Cable lengths

• Mains line AC 230 V	Max. 100 m (100 pF/m)
• Display, BCI	For installation under the burner hood or in the control panel Max. 3 m (100 pF/m)
• Load controller X5-03	Max. 20 m (100 pF/m)
• Safety loop / burner flange (total)	Max. 20 m (100 pF/m)
• External lockout reset button	Max. 20 m (100 pF/m)
• Safety valve	Max. 20 m (100 pF/m)
• Load output ¹⁾	Max. 10 m (100 pF/m)
• Fuel valve V1 / V2 / V3	Max. 3 m (100 pF/m)
• Pilot valve	Max. 3 m (100 pF/m)
• Ignition transformer	Max. 3 m (100 pF/m)
• Other lines	Max. 3 m (100 pF/m)

¹⁾ Do not run the cable together with other cables. If not observed, hum voltage might cause electromagnetic interference

Specification as per EN 60730-1

Type of shutdown or interruption of each circuit	
Shutdown with microswitch	1-pole
Mode of operation	Type 2 B

4.1.5 Cross-sectional areas

The cross-sectional areas of the mains power lines (L, N, and PE) and, if required, the safety loop (safety limit thermostat, water shortage, etc.) must be sized for rated currents according to the selected external primary fuse. The cross-sectional areas of the other cables must be sized in accordance with the internal unit fuse (max. 6.3 AT).

Min. cross-sectional area	0.75 mm ² (single- or multi-core as per VDE 0100)
---------------------------	---

Cable insulation must meet the relevant temperature requirements and environmental conditions.

Fuses (F1) used inside the LMV27	6.3 AT DIN EN 60127 2 / 5
----------------------------------	---------------------------

4.1.6 Connections of actuators

The ready connected actuator cables must not be extended.

4.2 AGV50 signal cable from AZL2 → BCI

Signal cable	Color white Unshielded Conductor 4 x 0.141 mm ² With RJ11-plug
Cable length	
- AGV50.100	1 m
- AGV50.300	3 m
Location	Under the burner hood (extra measures required for SKII EN 60730-1)

4.3 Environmental conditions

Storage	DIN EN 60721-3-1
Climatic conditions	Class 1K3
Mechanical conditions	Class 1M2
Temperature range	-20...+60 °C
Humidity	<95 % r.h.
Transport	DIN EN 60721-3-2
Climatic conditions	Class 2K2
Mechanical conditions	Class 2M2
Temperature range	-30...+60 °C
Humidity	<95 % r.h.
Operation	DIN EN 60721-3-3
Climatic conditions	Class 3K3
Mechanical conditions	Class 3M3
Temperature range	-20...+60 °C
Humidity	<95 % r.h.
Installation altitude	Max. 2,000 m above sea level



Caution!
Condensation, formation of ice and ingress of water are not permitted!

4.4 Flame detectors

4.4.1 Ionization probe

No-load voltage at ION terminal (X10-05 pin 2)	Approx. U_{Mains}
---	----------------------------



Caution!

The ionization probe must be protected against electric shock hazard!

Short-circuit current	Max. AC 1 mA
Required detector current	Min. DC 2.3 μA , flame display approx. 30%
Possible detector current	Max. DC 12...30 μA , flame display approx. 100 %
Max. perm. length of detector cable (laid separately)	3 m (wire-ground 100 pF/m)



Warning!

Simultaneous operation of QRA and ionization probe is not permitted!



Note

The higher the detector cable's capacitance (cable length), the more voltage at the ionization probe, and thus the detector current, drops. Long cable lengths plus very highly resistive flames might necessitate low-capacitance detector cables (e.g. ignition cable). In spite of technical measures taken in the circuitry aimed at compensating potential adverse effects of the ignition spark on the ionization current, it must be made certain that the minimum detector current required will already be reached during the ignition phase. If this is not the case, the connections on the primary side of the ignition transformer must be changed and / or the electrodes relocated.

Threshold values when flame is supervised by an ionization probe:

- Start prevention (extraneous light) Intensity of flame (parameter 954) $\geq 18\%$
- Operation Intensity of flame (parameter 954) $> 24\%$

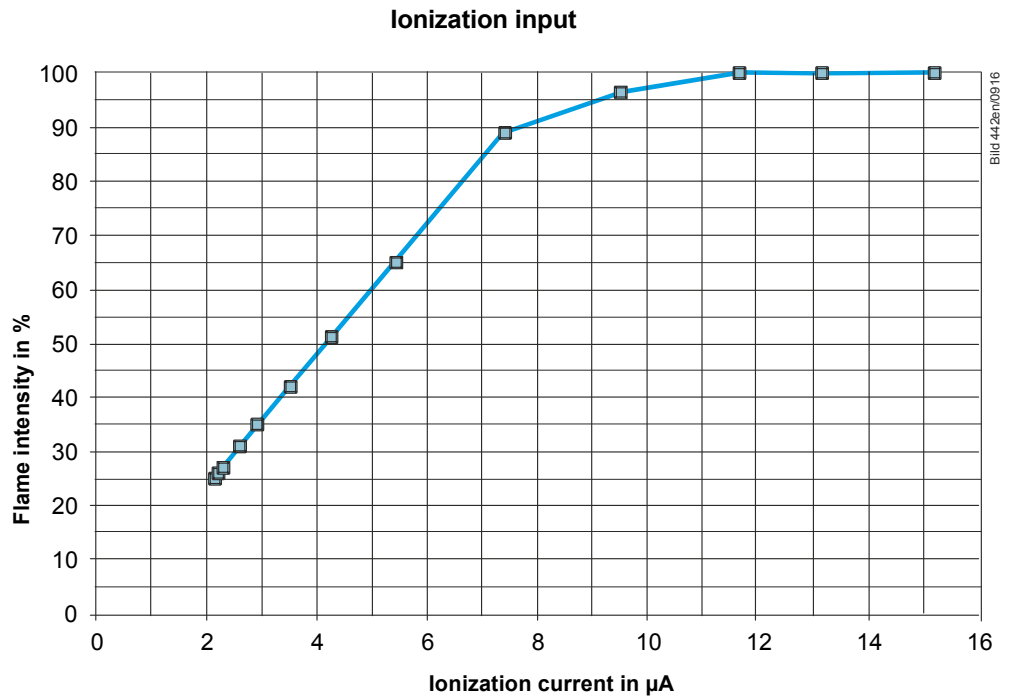

Figure 5: Ionization input at AC 230 V

Measuring circuit for
detector current
measurement

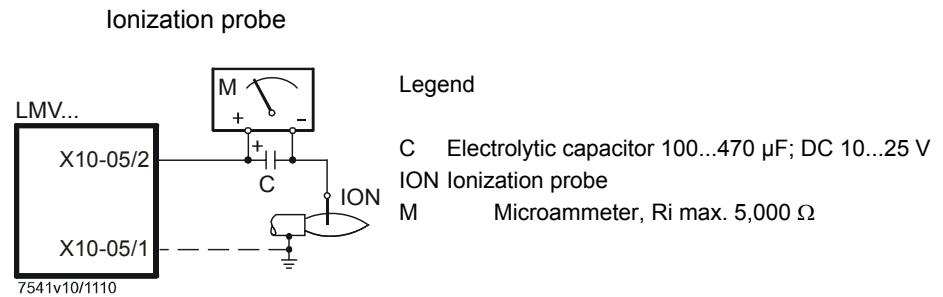

Figure 6: Measuring circuit for ionization probe

4.4.2 UV flame detectors QRA2 / QRA4 / QRA10



Caution!

If QRA2-UV tubes / QRA4-UV tubes / QRA10-UV tubes are used for flame supervision on the LMV27, it must be ensured that the basic unit is permanently connected to power (EN 298), thus enabling the LMV27 to detect flame detector failures during startup and shutdown.

Generally, the LMV27 works with QRA flame detectors in intermittent operation. For technical data, refer to Data Sheet N7712 covering QRA2 / QRA10 UV flame detector!

For technical data, refer to Data Sheet N7711 covering QRA4 UV flame detector!

Operating voltage	Max. 350 V peak
Required detector current in the operation mode	Min. 30 μ A
Possible detector current in the operation mode	Max. 600 μ A
Permissible length of detector line normal cable, lay separate	Max. 6 m
Threshold values when flame is supervised by QRA:	
- Start prevention (extraneous light)	Intensity of flame (parameter 954) \geq 18%
- Operation	Intensity of flame (parameter 954) $>$ 24%

Measuring circuit for detector current measurement

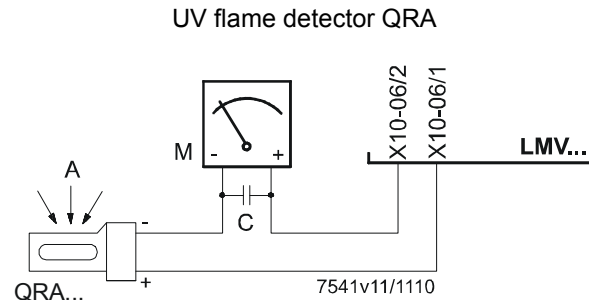

Figure 7: Measuring circuit QRA

Legend

- A Incidence of light
- C Electrolytic capacitor 100...470 μ F; DC 10...25 V
- M Microammeter R_i max. 5000 Ω



Warning!

- **Input QRA is not short-circuit-proof!**
Short-circuits of X10-06/2 against earth can destroy the QRA input
- **Simultaneous operation of QRA and ionization probe is not permitted!**

4.4.3 Photoresistive flame detectors QRB1 / QRB3

No-load voltage at QRB1/QRB3 terminal (X10-05 pin 3)	Approx. DC 5 V
Max. perm. length of QRB1/QRB3 detector cable (laid separately)	3 m (wire – wire 100 pF/m)



Note
 A detector resistance of $R_F < 500 \Omega$ is identified as a short-circuit and leads to safety shutdown in operation as if the flame had been lost.

For this reason, before considering the use of a highly sensitive photoresistive detector (QRB1B or QRB3S), it should be checked whether this type of flame detector is indeed required! Increased line capacitance between QRB1/QRB3 connection and mains live wire L has an adverse effect on the sensitivity and increases the risk of damaged flame detectors due to overvoltage. Always run detector cables separately!

Threshold values when flame is supervised by QRB1/QRB3:	
Start prevention (extraneous light) with R_{QRB}	<400 k Ω Intensity of flame $\geq 10\%$
Operation with R_{QRB}	<230 k Ω Intensity of flame >16%
Short-circuit detection with R_{QRB}	<0.5 k Ω

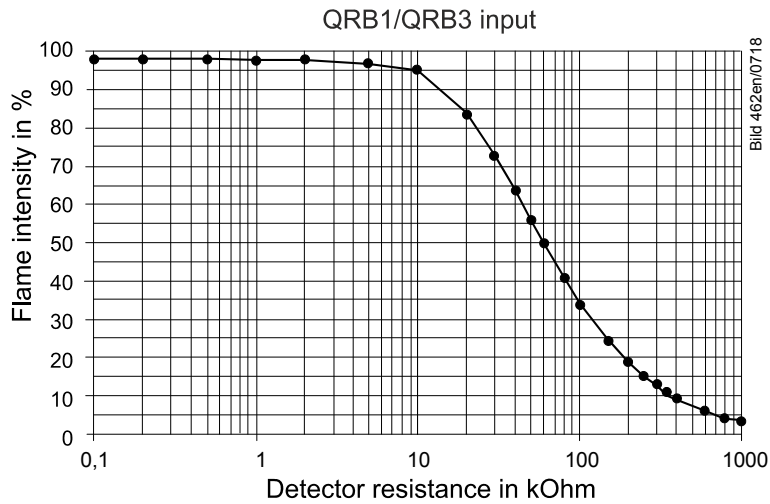

Figure 8: QRB1/QRB3 input at AC 230 V

A flame detector resistance of $R_F < 500 \Omega$ is identified as a short-circuit and leads to safety shutdown in operation, like in the case of loss of flame.

4.4.4 Yellow flame detector QRB4

Open-circuit voltage at terminal QRB4 (X10-05 pin 3)	Approx. 5 V DC
Permissible length of QRB4 detector cable (laid separately)	3 m (wire to wire 100 pF/m)
Threshold values when flame is supervised by QRB4	
Start prevention (extraneous light)	Flame intensity (parameter 954) $\geq 10\%$
Operation	Flame intensity (parameter 954) $> 16\%$



Note!

In the case of the QRB4, the maximum intensity display is limited to approximately 40% due to the system (parameter 954).



Note!

Connection of QRB4 cables!

Blue cable of QRB4 to terminal X10-05 pin 4.
Black cable of QRB4 to terminal X10-05 pin 3.
Otherwise, the QRB4 will not work.

4.4.5 Blue-flame detectors QRC

Check the intensity of flame with the AZL2.

For system-specific reasons, the display of maximum flame intensity by the AZL2 is limited to approx. 55%.



Caution!

Flame detectors QRC are only suited for AC 230 V operation.

Start prevention (extraneous light) with IQRC	Ca. 15 μA , display approx. 10 % Intensity of flame (parameter 954)
Operation with IQRC	Ca. 25 μA , display approx. 16 % Intensity of flame (parameter 954)

	Required detector current (with flame)	Permissible detector current (without flame)	Typical detector current (with flame)
QRC	Min. 70 μA	Max. 5,5 μA	100 μA

The values given in the table above only apply under the following conditions:

- Mains voltage AC 230 V
- Ambient temperature 23 °C

Measuring circuit for
detector current
measurement

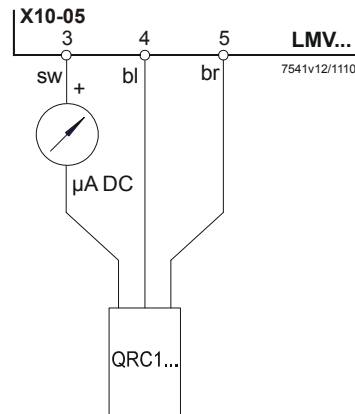

Legend

- $\mu\text{A DC}$ DC-Mikroampèremeter an internal resistance of $R_i = \text{max. } 5 \text{ k}\Omega$
- bl blue
- sw black
- br brown

Figure 9: Measuring circuit QRC

5 Dimensions

5.1 LMV27

Dimensions in mm

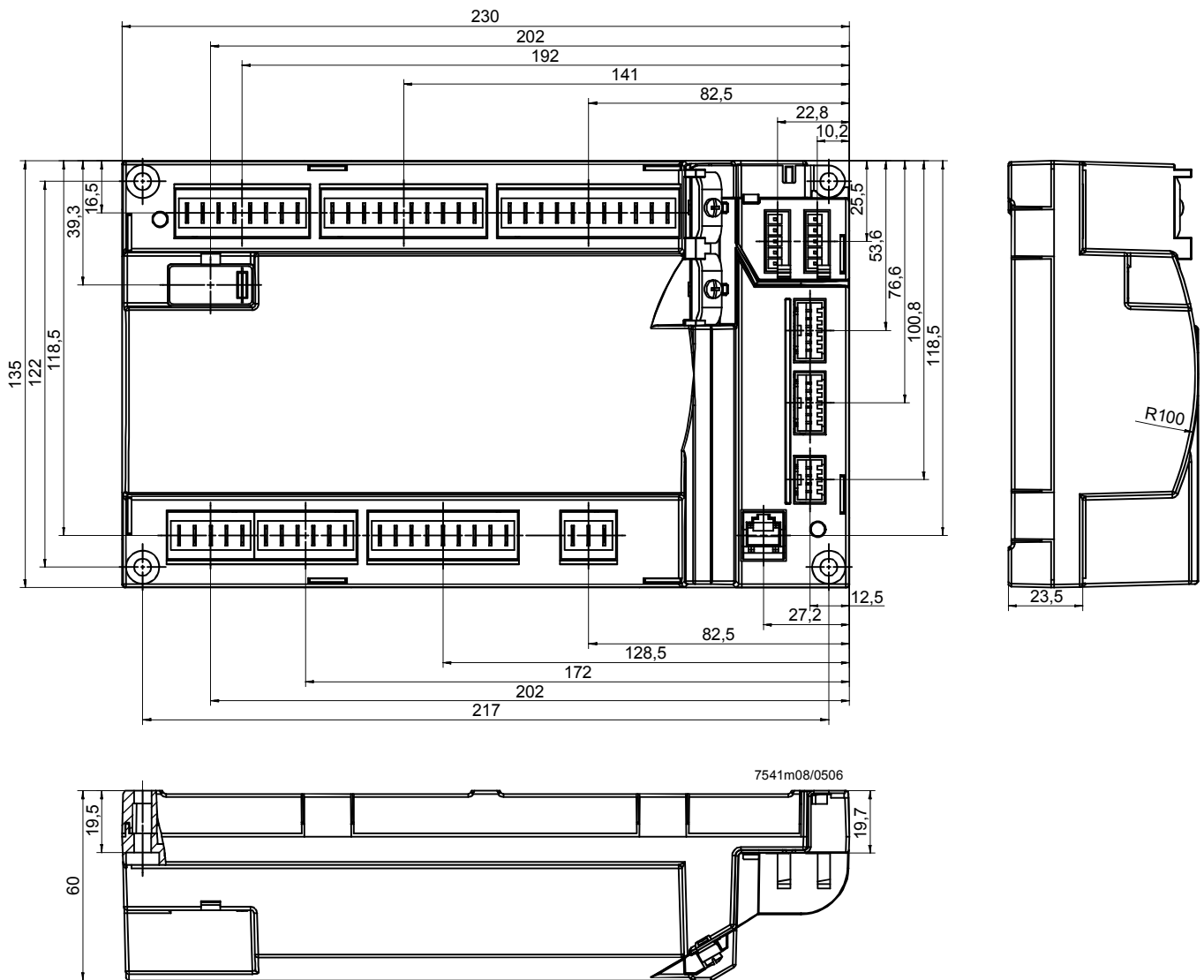

Figure 10: Dimensions of the LMV27

6 Display and diagnostics

Transmission of operating states, fault status messages and detailed service information via:

BCI communication via integrated RJ11 jack to the AZL2, or via additional OCI410 interface to ACS410 PC software

Communication / parameterization

AZL2

The AZL2 offers ease of operation, parameterization and targeted diagnostics via features menu-driven operation. When making diagnostics, the display shows operating states, the type of error and startup meter reading. Passwords protect the different parameter levels of the burner / boiler manufacturer and heating engineer against unauthorized access.

ACS410 PC software

ACS410 PC software enabled a simple operation, comfortable readout of settings and operating states, the parameterization, trend recording and targeted diagnostic of LMV27.

For this purpose, the OCI410 interface for communication with the LMV27 is connected to the PC. This interface is available separately and is connected to the integrated RJ11 jack.

7 Basic unit LMV27

7.1 Description of inputs and outputs

This section covers the key features of the LMV27's inputs and outputs. For exact use of the inputs and the activation of outputs, refer to chapter *Sequence diagrams*.

Flame signal input and flame detector X10-05 and X10-06

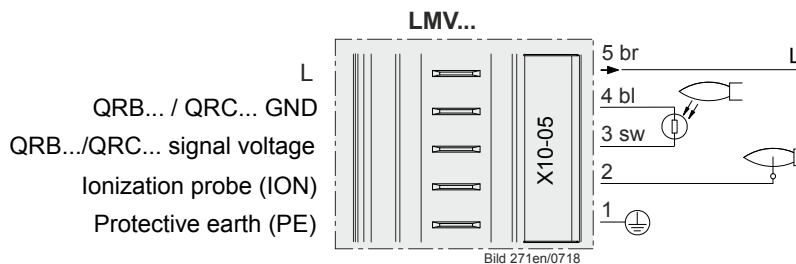

Figure 11: Flame signal input X10-05

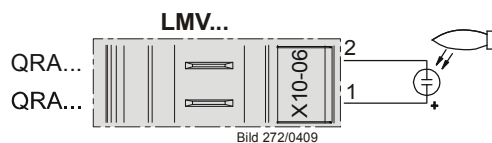

Figure 12: Flame signal input X10-06

Connection choices:

- Ionization probe
- QRA2 / QRA10
- QRA4
- QRB
- QRC

7.2 Flame detectors

For display of the flame on the AZL2, the following general conditions apply:

- Display is subject to various component tolerances, which means that deviations of $\pm 10\%$ can occur
- Note that, for physical reasons, there is no linear relationship between flame display and detector signal values

The LMV27 can be used with different types of flame detectors. For the correct use of flame detectors, refer to the chapter *Sequence diagrams*.

The flame detector used must be correctly parameterized.

In the hardware of the LMV27, the flame signals are subdivided into 2 groups (group 0 covering the QRB and QRC, and group 1 covering ionization and the QRA). The flame detector for gas is selected via parameter 221, that for oil via parameter 261.

No.	Parameter
221	Gas: Active detector flame evaluation 0 = QRB / QRC 1 = ION / QRA
261	Oil: Active detector flame evaluation 0 = QRB / QRC 1 = ION / QRA

7.2.1 Loss of flame

In the event of loss of flame, the unit initiates safety shutdown, followed by a restart, if required. A repetition counter can be used to select the number of flame losses after which the unit shall initiate lockout (refer to chapter *Repetition counter*).

Error code	Diagnostic code	Meaning for the LMV27
7	0	Loss of flame

No.	Parameter
186	Software drop out delay time of flame signal (100 ms) Index 0 = QRB / QRC (0 = deactivated, >1 = activated) Index 1 = ION / QRA (0 = deactivated, >3 = activated) (only 200 ms-steps)
194	Repetition limit no flame at the end of safety time (TSA) 1 = no repetition 2...4 = 1...3 repetitions Recharging time: Entering into operation
240 280	Repetition limit value loss of flame 1 = no repetition 2 = 1 repetition Recharging time: After the <i>Operation</i> phase



Caution!

The response time of the flame detector leads to an extension of the second safety time! This must be taken into consideration when designing the burner!

7.2.2 Extraneous light

Extraneous light in *Standby* mode (phase 12) leads to start prevention, followed by a restart. Extraneous light during the prepurge phase results in immediate lockout. If extraneous light occurs during the shutdown phase, the LMV27 switches to the safety phase.

One repetition is permitted. This means that if the error occurs again the next time the system is shut down, the unit will initiate lockout.

Error code	Diagnostic code	Meaning for the LMV27
4	0	Extraneous light during the startup phase
	1	Extraneous light during the shutdown phase
	2	Extraneous light during the startup phase – start prevention

7.2.3 No flame at the end of safety time (TSA)

If no flame is established by the end of the first safety time, the unit initiates lockout.

Error code	Diagnostic code	Meaning for the LMV27
2	1	No flame at end of the first safety time
	2	No flame at end of the second safety time

7.2.4 Flame intensity

The flame's intensity can be displayed.
It is standardized from 0...100%.

No.	Parameter
954	Intensity of flame



Note

Also refer to chapter *Intensity of flame during curve settings*.

7.2.5 Supervision of flame detector

Error code	Diagnostic code	Meaning for the LMV27
93	3	Short-circuit of flame detector

At the QRB / QRC flame detector's input, the LMV27 checks the detector for short-circuits in operation.

7.3 Digital input

7.3.1 Safety loop X3-04, pin 1 and 2

Input for connection of the safety loop. When any of the series-connected contacts included in the loop opens, power supply to the fuel valves, the fan and the ignition equipment is instantly cut.

The safety loop includes the following components:

- External burner switch (ON / OFF)
- Safety limiter / safety pressure limiter
- External control thermostat and / or pressurestat, if required
- Water shortage switch



Note
Pressure switch-max when using POC via X5-02.

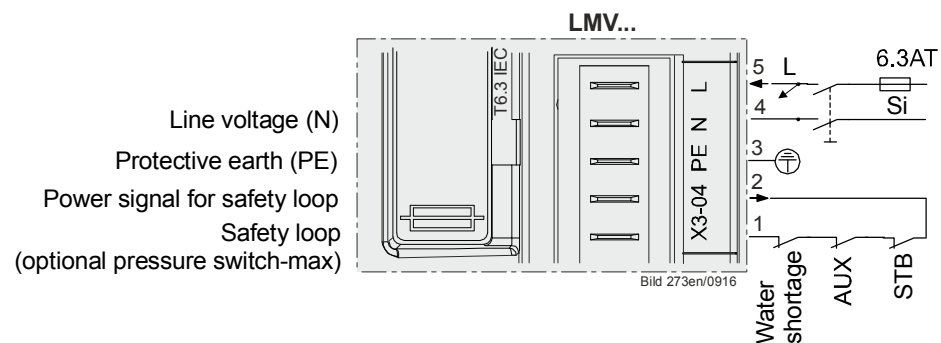

Figure 13: Safety loop X3-04

For diagnostic purposes, the contacts of the components included in the safety loop and the burner flange contact are combined for delivering the safety loop signal. If there is no such signal, the system initiates safety shutdown in any event.

If, with *Load controller ON*, there is no signal from the safety loop (start prevention), error code 22 is translated to text display **OFF S** (S = safety loop) and the numerical value appears in the error history.

Error code	Diagnostic code	Meaning for the LMV27
22 OFF S	0	Safety loop/burner flange Open

For the input, a repetition counter can be parameterized. Here, it is possible to set the number of errors permitted until lockout occurs (refer to chapter *Repetition counter*).

No.	Parameter
215	Repetition limit safety loop 1 = no repetition 2...15 = 1...14 number of repetitions 16 = constant repetition Recharging time: Every 24 hours



Attention!
In the safety loop, temporarily (<1 s) switching contacts must not be wired (switch or other)!

7.3.2 Burner flange X3-03, pin 1 and 2

End switch burner flange (component of safety loop).

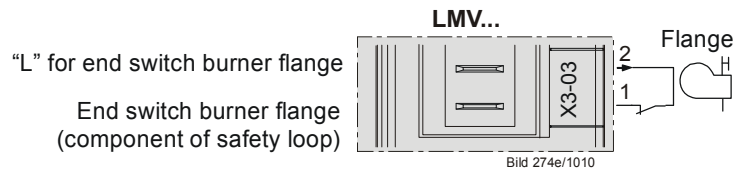

Figure 14: Burner flange X3-03

For error diagnostics and parameters, refer to chapter *Safety loop*.

7.3.3 Input for external load controller (ON / OFF) X5-03, pin 1

When the external control loop is closed, the internal input message *Heat request* is generated.

A heat request exists when the external load controller signal is pending and, depending on the configuration, a load controller calls for heat (refer to chapter *Connection of load controllers*).

When there are no more requests for heat, the burner shuts down. The fuel valves are closed, either immediately when the timer has elapsed, or when the low-fire position is reached, depending on the parameter settings (refer to chapter *End of operating position*).



Note
Burner startup takes place only when this contact is closed.

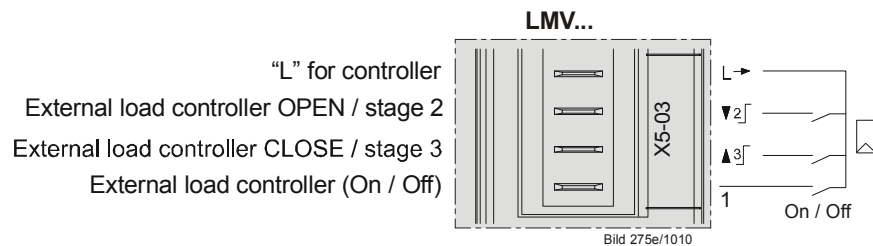

Figure 15: Inputs for external load controller ON / OFF X5-03

7.3.4 Inputs X5-03 pin 2 and 3 (Opening / Closing or stage 2 / stage 3)

Inputs for connection of an external load controller with contact outputs (refer to chapter *External load controller via contacts X5-03, pin 2 and 3*).

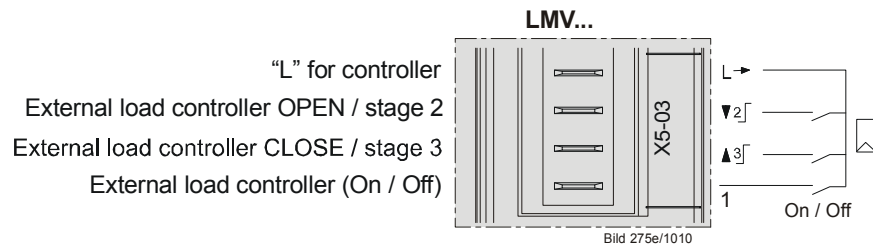

Figure 16: Inputs external load controller Open / Close X5-03

7.3.5 Air pressure switch X3-02

Input for connection of an air pressure switch. Air pressure is anticipated when the fan is switched on. If there is no air pressure signal, the system initiates lockout. The air pressure switch must have an NO contact.

If no air pressure switch is required (e.g. when firing on oil), a wire link to the fan output must be fitted (between X3-02, pin 1, and X3-05, pin 1).



Caution!

The OEM must check to see whether the burner can be operated without air pressure switch. This may necessitate a special approval, depending on the type of application.

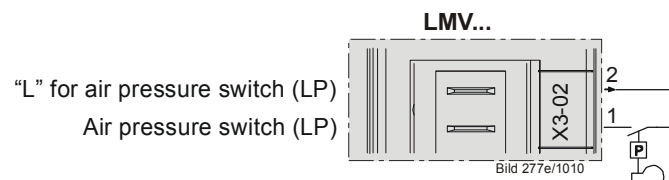

Figure 17: Air pressure switch X3-02

No.	Parameter
235	Air pressure switch 1 = active 2 = active, except phase 60...66 / 70...72 (pneumatic operation only)

Error code	Diagnostic code	Meaning for the LMV27
3	0	Air pressure off
	1	Air pressure on
	4	Air pressure on – start prevention

For the input, a repetition counter can be parameterized. Here, it is possible to set the number of errors that are permitted until lockout occurs (refer to subsection *Repetition counter*).

No.	Parameter
196	Repetition limit air pressure failure 1 = no repetition 2 = 1 repetition 3 = 2 repetitions Recharging time: End of <i>Shutdown</i> phase

7.3.6 Gas pressure switch for valve proving X9-04

Input for connection of *Pressure switch valve proving X9-04*. The input is active only when operating on gas and when valve proving is activated (refer to chapter *Program sequence*).

No.	Parameter
241	Gas: Execution valve proving 0 = no valve proving 1 = valve proving on startup 2 = valve proving on shutdown 3 = valve proving on startup and shutdown

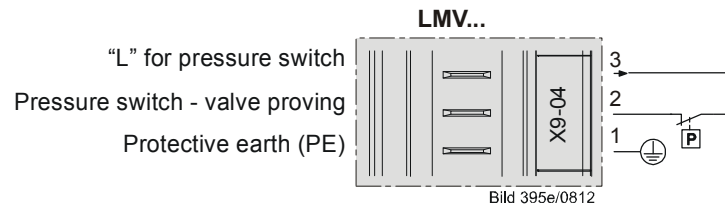

Figure 18: Gas pressure switch valve proving X9-04

Pressure switch valve proving

Input for connection of valve proving with a specific pressure switch. The input is active only when firing on gas and when valve proving is activated.

Error code	Diagnostic code	Meaning for the LMV27
12	81	Fuel valve V1 leaking
	83	Fuel valve V2 leaking



Note

When using configuration *Valve proving via gas pressure switch-min*, it is not possible to use the input for *Start release gas*.

7.3.7 Gas / oil pressure switch-min, start release gas X5-01

Input for connection of a pressure switch-min for gas or oil: If the plant does not require a pressure switch-min, a wire link must be fitted between pin 2 and 3.

Pressure switch-min-gas

The LMV27 enables parameterization of which gas train position the gas pressure switch-min is mounted on. This also influences the time of the input evaluation.

No.	Parameter
236	Gas: Input pressure switch-min 1 = pressure switch-min before fuel valve V1 (default setting) 2 = valve proving (between fuel valve V1 and fuel valve V2) via pressure switch-min 3 = pressure switch-min after fuel valve V2

In all types of gas trains, the minimum gas pressure is expected from phase 22 in the default setting (value 1).

If no gas pressure is detected when the maximum time (parameter 214) has elapsed, the gas shortage program is started (refer to chapter *Gas shortage program*).

If value 2 is set, the gas shortage check only takes place in phase 39 or in conjunction with a potential valve proving as part of commissioning. When the gas pressure switch-min is mounted after the fuel valves, a gas shortage check cannot be carried out. The supervision of the gas pressure is only carried out from phase 40 (direct ignition) or from phase 50 (pilot ignition) depending on the fuel train used.

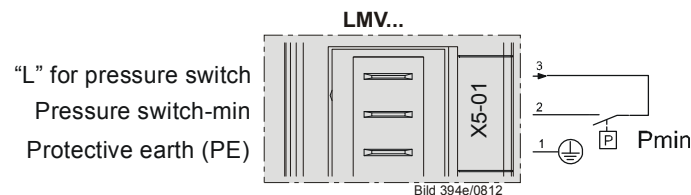

Figure 19: Gas pressure switch-min / oil pressure-min X5-01



Caution!

The OEM must check to see whether the burner can be operated without pressure switch-min. This may necessitate a special approval, depending on the type of application.

No.	Parameter
214	Maximum time start release

During the safety times, the signal received from pressure switch-min is only assessed after a certain period of time in order to ignore the pressure shocks that occur the moment the valves open. The time to elapse for signal assessment can be parameterized.

No.	Parameter
229	Gas: Time to respond to pressure faults in the first and second safety time

If there is no gas pressure, at least safety shutdown is initiated.

Error code	Diagnostic code	Meaning for the LMV27
20	0	Pressure switch-min No minimum gas / oil pressure
20	1	Gas shortage start prevention
23	0	Pressure switch-min No minimum gas / oil pressure
23	1	Gas shortage start prevention

For the input, a repetition counter can be parameterized. It can be used to set the number of errors permitted until lockout occurs. The counter also impacts the gas shortage program (refer to chapter *Repetition counter*).

No.	Parameter
223	Repetition limit value gas pressure switch-min 1 = no repetition 2...15 = 1...14 number of repetitions 16 = constant repetition Recharging time: After the <i>Operation</i> phase

Start release gas

If, at the same time, the input is used as a start release input (e.g. for an air supply damper), it can be connected in series with the pressure switch.
When selecting *Valve proving via pressure switch-min* (parameter 236), function *Start release gas* is not supported.

No.	Parameter
236	Gas: Input pressure switch-min 1 = pressure switch-min before fuel valve V1 (default setting) 2 = valve proving (between fuel valve V1 and fuel valve V2) via pressure switch-min 3 = pressure switch-min after fuel valve V2

Oil pressure switch-min

In all types of oil train, the minimum oil pressure is expected from phase 38. If no oil pressure is detected when the maximum time (parameter 217) has elapsed or if, subsequently, the oil pressure drops, the system initiates lockout.

No.	Parameter
217	Maximum waiting time for detecting a detector or pressure switch signal (e.g. home run, preignition)

Error code	Diagnostic code	Meaning for the LMV27
20	0	Pressure switch-min No minimum gas / oil pressure
20	1	Gas shortage start prevention

During the safety times, the signal from pressure switch-min is only assessed after a certain period of time in order to ignore the pressure shocks that occur the moment the valves open. The time to elapse for signal assessment can be parameterized.

No.	Parameter
269	Oil: Time to respond to pressure faults in the first and second safety time

7.3.8 Setting the time for making the pressure switch test

For oil pressure switch-min, the point in time after which the evaluation is made can be set via parameter 276 (active from phase 38, or from the safety time (TSA)).

No.	Parameter
276	Oil: Input pressure switch-min 1 = active from phase 38 2 = active from safety time

7.3.9 Gas / oil pressure switch-max / oil pressure-max or POC contact, start release oil X5-02

Input for connection of a pressure switch-max for gas or oil: The pressure switch must have an NC contact, which means that the contact opens when the adjusted maximum pressure is exceeded. If the plant does not require a pressure switch-max, a wire link must be fitted between pin 2 and 3.



Caution!
The OEM must check to see whether the burner can be operated without pressure switch-max. This may necessitate a special approval, depending on the type of application.

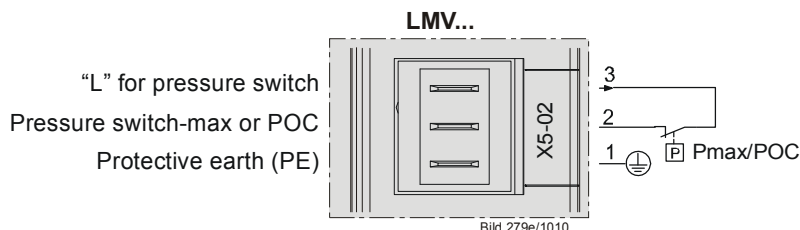

Figure 20: Gas pressure-max / oil pressure switch-max or POC X5-02

The connection facility can also be used as POC (proof of closure) (refer to chapter *Sequence diagrams*).

No.	Parameter
237	Gas: Input pressure switch-max / POC 1 = pressure switch-max 2 = POC 3 = pressure switch valve proving 4 = not uses



Note
 If the input is used for POC or pressure switch, pressure switch-max can be included in the safety loop. In that case, pressure switch-max must not be fitted between the valves, but downstream from them.

Gas pressure switch-max

In all types of gas trains, the maximum gas pressure is monitored from phase 40. If the maximum gas pressure is exceeded, the system initiates lockout.

Error code	Diagnostic code	Meaning for the LMV27
14	0	POC open
	1	POC close
21	0	Pressure switch-max: Maximum gas pressure exceeded POC: POC open (software version ≤V02.00)
	1	POC close (software version ≤V02.00)

During the safety times, the signal from pressure switch-max is only assessed after a certain period time has elapsed in order to ignore the pressure shocks that occur the moment the valves open.

No.	Parameter
229	Gas: Time to respond to pressure faults in the first and second safety time

Oil pressure switch-max

In all types of oil trains, the maximum oil pressure is monitored from phase 22. If the maximum oil pressure is exceeded after the maximum time (parameter 214) has elapsed, or during the subsequent phases, the system initiates lockout.

No.	Parameter
214	Maximum time to start release

Error code	Diagnostic code	Meaning for the LMV27
14	0	POC open
	1	POC close
21	0	Pressure switch-max: Maximum oil pressure exceeded POC: POC open (software version \leq V02.00)
	1	POC close (software version \leq V02.00)

During the safety times, the signal from pressure switch-max is only assessed after a certain period of time has elapsed in order to ignore the pressure shocks that occur the moment the valves open.

No.	Parameter
269	Oil: Time to respond to pressure faults in the first and second safety time

The pressure switch connection can also be used as POC (Proof of Closure) (refer to chapter *Sequence diagrams*).

No.	Parameter
277	Oil: Input pressure switch-max / POC 1 = pressure switch-max 2 = POC 3 = not used 4 = additional speed-dependent air pressure switch



Note

If the input is used for POC, pressure switch-max can be included in the safety loop. In that case, pressure switch-max must not be installed between the valves, but always downstream from them.

Start release oil

If the input is simultaneously used as a start release input, e.g. for an air supply damper, the latter can be connected in series with the pressure switch.

Whit parameterization with POC function cannot be used as start release input.

7.3.10 Reset X8-04, pin 1

Input for connection of a reset button. The LMV27 can be reset or manually locked via this input (refer to chapter *Reset/manual locking*).



Figure 21: Reset X8-04

7.4 Digital outputs

Safety-related outputs, type SI

Using a contact feedback network (CFN), these contacts are read back by the microcomputers and checked for their correct positions.

Non-safety-related outputs, type No-SI

These outputs are not monitored by the contact feedback network and, for this reason, can only be used for non-safety-related actuators, or actuators made safe in some other form (e.g. alarm).

7.4.1 Output alarm type No-SI – X3-05, pin 2

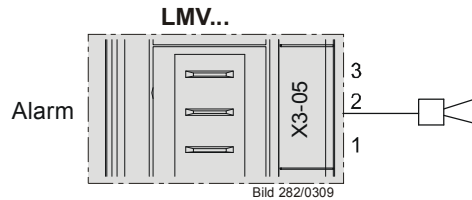

Figure 22: Output alarm X3-05

Output for connection of an alarm lamp or horn. The output is activated when the LMV27 is in the lockout position (phase 00). This output can also be used to indicate start prevention.

7.4.2 Fan motor contactor type SI – X3-05, pin 1

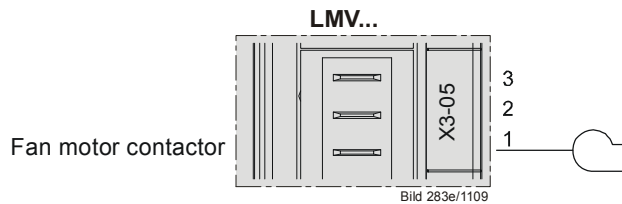

Figure 23: Fan motor contactor X3-05

Output for control of a fan power contactor (200 VA). In accordance with the sequence diagrams, the fan is on in phase 22 (refer to chapter *Sequence diagrams*).

7.4.3 Continuous fan operation – X3-05, pin 3

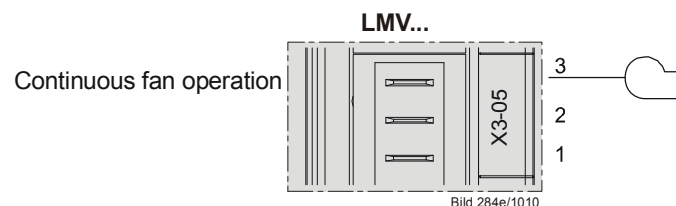

Figure 24: Continuous fan operation X3-05

If continuous purging is required, the fan motor contactor must be connected to *Continuous fan operation – X3-05, pin 3*. This terminal is tapped behind the unit fuse and the safety loop (refer to chapter *Continuous fan*).

7.4.4 Output ignition type SI (IGNITION) – X4-02

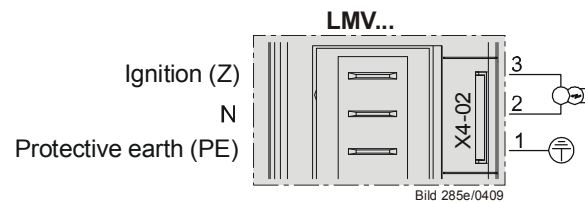

Figure 25: Output ignition X4-02

Output for the connection of ignition transformers or electronic ignition modules.

Gas

When firing on gas, ignition is switched on just prior to the first safety time in phase 38.

The preignition time in phase 38 can be parameterized.

No.	Parameter
226	Gas: Preignition time

Oil

When firing on oil, there is a choice between long and short preignition (as with gas operation from phase 38).

No.	Parameter
281	Oil: Point in time oil is ignited 0 = short preignition (phase 38) 1 = long preignition (with fan) (phase 22)

When using long preignition, ignition is switched on in phase 22, together with the fan.

In the case of short preignition, the preignition time can be parameterized.

No.	Parameter
266	Oil: Preignition time

7.4.5 Outputs fuel valves V1 / V2 / V3 / PV, type SI – X8-02, X7-01, X7-02

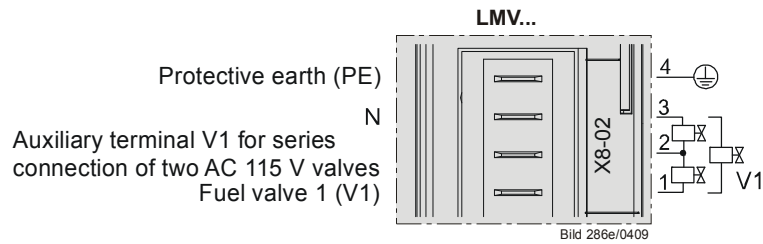

Figure 26: Output fuel valve V1 X8-02

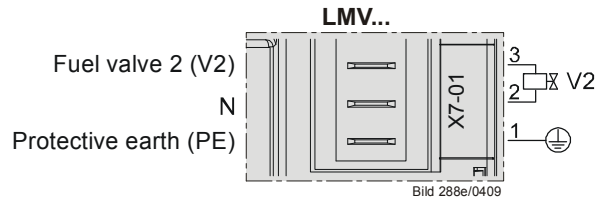

Figure 27: Output fuel valve V2 X7-01

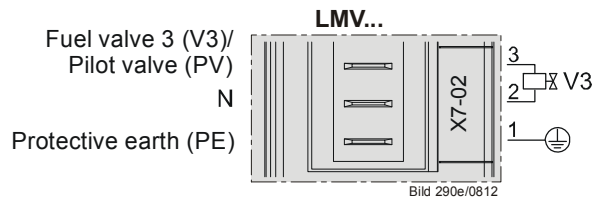

Figure 28: Output fuel valve V3 / pilot valve X7-02

Outputs for connection of the gas or oil valves, depending on the selected type of fuel train (refer to chapter *Sequence diagrams*).

7.4.6 Output safety valve type SI – X6-03

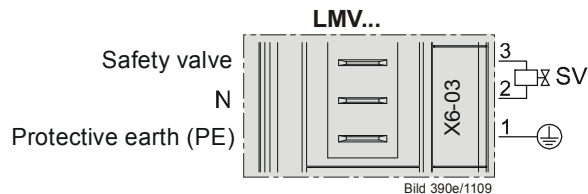

Figure 29: Output safety valve X6-03

Output for connection of an oil valve or safety valve for liquefied gas. The output is connected parallel to the output for the fan.

7.4.7 Output for indication of operation X8-04, pin 2

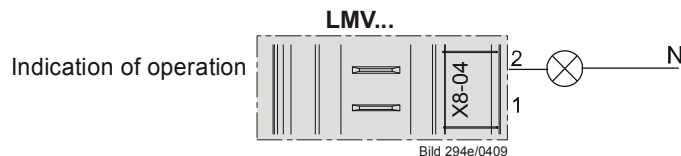

Figure 30: Output for indication of operation X8-04

Output for connection of indication of operation.



Caution!
The output is connected parallel to the fuel valve V1.

7.5 Program sequence

The program sequence is shown in the form of sequence diagrams (refer to chapter *Fuel trains*). Using a number of parameters, the program sequence can be adapted to the respective application.

7.5.1 Time parameters

Using a number of time parameters, the time characteristics of the different types of fuel trains can be matched to the requirements of the respective application.

No.	Parameter
211	Fan rump-up time
212	Maximum time to low-fire
213	Waiting time home run
214	Maximum time to start release
217	Max. Waiting time for detection of detector or pressure signal (e.g. homerun, preignition «Lo»)
225	Gas: Prepurge time
226	Gas: Preignition time
227	Gas: First safety time
229	Gas: Time to respond to pressure faults in the first and second safety time
230	Gas: Interval 1
231	Gas: Second safety time
232	Gas: Interval 2
233	Gas: Afterburn time
234	Gas: Postpurge time (no extraneous light test)
242	Gas: Valve proving - test space evacuating
243	Gas: Valve proving - test time atmospheric pressure
244	Gas: Valve proving - test space filling
245	Gas: Valve proving - test time gas pressure
246	Gas: Waiting time gas shortage
248	Gas: Postpurge time (abortion if load controller ON)
249	Gas: Prepurge time (OEM)
265	Oil: Prepurge time
266	Oil: Preignition time
267	Oil: First safety time
269	Oil: Time to respond to pressure faults in the first and second safety time
270	Oil: Interval 1
271	Oil: Second safety time
272	Oil: Interval 2
273	Oil: Afterburn time
274	Oil: Postpurge time (no extraneous light test)
284	Oil: Postpurge time (abortion if load controller ON)



Caution!

The OEM or the heating engineer must make certain that the times conform to the standards covering the respective type of plant.

7.5.2 Valve proving

Valve proving is only active when firing on gas. Valve proving designed to detect leaking gas valves and, if necessary, to prevent the valves from opening or ignition from being switched on. Lockout is initiated, if required.

When performing valve proving, the gas valve on the burner side is opened first to bring the test space to atmospheric pressure. After closing the valve, the pressure in the test space must not exceed a certain level. Then, the gas valve on the mains side is opened to fill the gas pipe. After closing, the gas pressure must not fall below a certain level.

Valve proving can be parameterized to take place on startup, shutdown, or on both. The type of valve proving can be selected via parameter 236.

Recommendation:

Perform valve proving on shutdown.

No.	Parameter
236	Gas: Input pressure switch-min 1 = pressure switch-min before fuel valve V1 (default setting) 2 = valve proving (between fuel valve V1 and fuel valve V2) via pressure switch-min 3 = pressure switch-min after fuel valve V2
237	Gas: Input pressure switch-max / POC 1 = pressure switch-max 2 = POC 3 = pressure switch valve proving 4 = additional speed-dependent air pressure switch
241	Gas: Execution valve proving 0 = no valve proving 1 = valve proving on startup 2 = valve proving on shutdown 3 = valve proving on startup and shutdown
242	Gas: Valve proving - test space evacuating
243	Gas: Valve proving - test time atmospheric pressure
244	Gas: Valve proving - test space filling
245	Gas: Valve proving - test time gas pressure



Caution!

If valve proving is parameterized to take place *on startup and shutdown*, the gas valves must run through additional switching cycles. As a result, strain on the gas valves (wear) will increase.



Caution!

The OEM must set the evacuation, filling and test times for atmospheric or mains pressure on every plant in compliance with the requirements of EN 1643.

It must be ensured that the 2 test times are correctly set. It is to be checked whether the gas required for the test may be fed into the combustion chamber (on the relevant application). The test times are safety-related. After a reset and in the case of aborted or prevented valve proving, the unit performs valve proving on the next startup (only when valve proving is activated). Prepurging with valve proving is active during the startup phase, even if it was deactivated.

Examples of aborted valve proving:

When the safety loop or the start prevention input for gas (containing pressure switch-min) opens during valve proving.

Valve proving – calculation of leakage rate

$$t_{\text{Test}} = \frac{(P_G - P_W) \cdot V \cdot 3600}{P_{\text{atm}} \cdot Q_{\text{Leck}}}$$

QLeck	in l/h	Leakage rate in liters per hour
PG	in mbar	Overpressure between the valves at the beginning of the test phase
PW	in mbar	Overpressure set on the pressure switch (normally 50% of the gas inlet pressure)
Patm	in mbar	Absolute air pressure (1013 mbar normal pressure)
V	in l	Volume between the valves (test volume) including valve volume and pilot pipe, if present (Gp1 mod)
tTest	in s	Test time

7.5.2.1. Valve proving with separate pressure switch X9-04

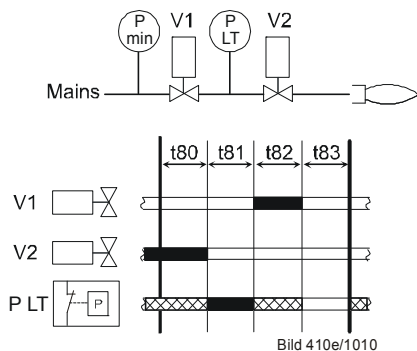

Figure 1: Valve proving with separate pressure switch

Step 1: t80 – evacuation of test space.

Gas valve on the burner side is opened to bring the test space to atmospheric pressure.

Step 2: t81 – test time atmospheric pressure.

When the gas valve has closed, the gas pressure in the test space must not exceed a certain level.

Step 3: t82 – filling of test space.

Gas valve on the mains side opens to fill the test space.

Step 4: t83 – test time gas pressure.

When the gas valve has closed, the gas pressure in the test space must not drop below a certain level.

Legend

t80	Evacuation of test space (parameter 242)
t81	Test time atmospheric pressure (parameter 243)
t82	Filling of test space (parameter 244)
t83	Test time gas pressure (parameter 245)
Vx	Fuel valve
P LT	Pressure switch – valve proving
Pmin	Pressure switch-min
	Input/output signal 1 (ON)
	Input/output signal 0 (OFF)
	Input permissible signal 1 (ON) or 0 (OFF)

7.5.2.2. Valve proving via gas pressure switch-min X5-01

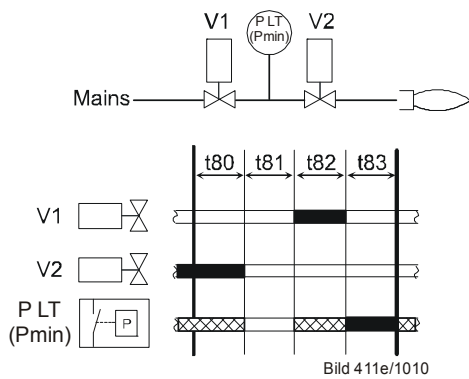

Figure 2: Valve proving via gas pressure switch-min

Step 1: t80 – evacuation of test space.

Gas valve on the burner side is opened to bring the test space to atmospheric pressure.

Step 2: t81 – test time atmospheric pressure.

When the gas has closed, the gas pressure in the test space must not exceed a certain level.

Step 3: t82 – filling of test space.

Gas valve on the mains side opens to fill the test space.

Step 4: t83 – test time gas pressure.

When the gas valve has closed, the gas pressure in the test space must not drop below a certain level.

Legend

- t80 Evacuation of test space (parameter 242)
- t81 Test time atmospheric pressure (parameter 243)
- t82 Filling of test space (parameter 244)
- t83 Test time gas pressure (parameter 245)
- Vx Fuel valve
- Pmin Pressure switch-min
- P LT Pressure switch – valve proving
- Input/output signal 1 (ON)
- Input/output signal 0 (OFF)
- Input permissible signal 1 (ON) or 0 (OFF)

When making the valve proving test via pressure switch-min-gas, the impact on the program sequence is as follows (see *Sequence diagram G*):

a) Valve proving on startup

In place of sampling pressure switch-min-gas (gas shortage test) in phase 22, it is sampled during the time valve proving is performed at the end of the filling time.

b) Valve proving on shutdown/deactivated

Pressure switch-min-gas is sampled at the end of preignition. For that purpose, a new phase 39 (Test *Pressure switch-min*) is introduced and evaluation of gas shortage is made at the end of the phase (duration of phase = filling time). In practice, this represents an *extension* of preignition by the filling time, if valve proving via pressure switch-min-gas was selected.

The valve proving test can only be made via pressure switch-min-gas, which must be fitted between the valves. This has an impact on the control sequence (refer to chapter *Sequence diagrams*). Valve proving is still activated via parameter 241.

No.	Parameter
241	Gas: Execution valve proving 0 = no valve proving 1 = valve proving on startup 2 = valve proving on shutdown 3 = valve proving on startup and shutdown

7.5.2.3. Lockout phase (phase 00)

The relays of the fuel valves and the safety relay (fan) are deenergized, the alarm relay is energized and lockout takes place. This means that phase 00 can only be quit via a manual reset. The time of phase 00 is unlimited.

7.5.2.4. Safety phase (phase 01)

The safety phase is an intermediate phase which is completed prior to triggering lockout. The relays of the fuel valves and the safety relay (fan) are deenergized, but lockout does not yet take place. The alarm relay is not yet activated. If possible or permitted, safety checks or repetition counter checks are made whose results decide on the transition to *Lockout phase* or *Standby*. The duration of the safety phase is dynamic (depending on the extent of testing), the maximum time being 30 seconds. This process is aimed primarily at avoiding unwanted lockouts, e.g. resulting from EMC problems.

7.5.3 Special functions during the program sequence

7.5.3.1 Reset / manual lockout

The LMV27 can be manually locked by simultaneously pressing the **Info** button and **any other button** on the AZL2. This function enables the operator to lock the LMV27 from any of the operating levels or, in other words, to trigger non-volatile lockout. Due to the system's structure, this does not represent an *Emergency OFF* function.

When making a reset, the following actions are carried out:

- Alarm relay and fault display are switched off
- The lockout position is canceled
- The LMV27 makes a reset and then changes to *Standby*

The LMV27 can be reset in 3 different ways:

1. Resetting on the AZL2

If the unit is in the lockout position, a reset can be made by pressing the **Info** button for 1...3 seconds. The function is available only when the unit is in the lockout position. Longer or shorter pushes on the button do not produce a reset so that the LMV27 maintains the lockout position.

Error code	Diagnostic code	Meaning for the LMV27
167	2	Manual lockout by the AZL2

2. Resetting by pressing the button by the *Reset* connection terminal on the LMV27 (X8-04, pin 1)

If the unit is in the lockout position, a reset can be made by pressing the button for 1...3 seconds. Longer or shorter pushes on the button are ignored so that the LMV27 maintains the lockout position.

If the unit is **not** in the lockout position and the reset button is pressed for 1...6 seconds, a change to the lockout position takes place.

If this response is not desirable, it is possible to tap the supply for the reset button from the alarm output, thus achieving the same response as described above under 1.

Error code	Diagnostic code	Meaning for the LMV27
167	1	Manual lockout via contact

Reset without manual lockout

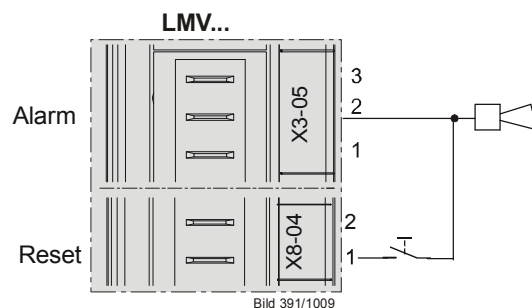

Figure 31: Without manual locking

Reset with manual lockout

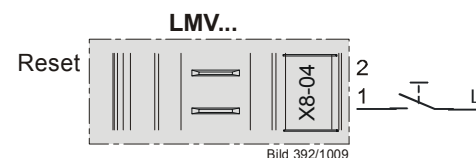

Figure 32: With manual locking

3. Resetting via the ACS410 PC software

Refer to the documentation covering the ACS410 PC software (J7352).

Error code	Diagnostic code	Meaning for the LMV27
167	3	Manual lockout via ACS410 PC software

7.5.3.2. Alarm upon start prevention

If start prevention occurs, it is shown on the display of the AZL2.

Start prevention takes place only when a heat request is delivered **and** when one of the startup criteria is not fulfilled.

The time to elapse from start prevention to display on the AZL2 is set to a fixed value of 5 seconds.

In addition, it is possible to indicate start preventions via the alarm output. This function can be activated per parameter.

No.	Parameter
210	Alarm in the event of start prevention 0 = deactivate 1 = activate

If *Alarm in the event of start prevention* is activated via the alarm relay, start prevention and lockout can only be distinguished via the display on the AZL2. Start preventions are displayed as **Err:**, lockouts as **Loc:**.



Note

If the reset contact X8-04 Pin 1 on the LMV27 is activated during a startup prevention, the LMV27 will be manually locked.

The time from occurrence of start prevention to indication by the alarm contact equals the time to the display on the AZL2.

7.5.3.3. Possible start preventions

On the normal display, error code 201 is translated to text display **OFF UPr** (UPr = unprogrammiert = not programmed); the numerical value appears in the error history.

Error code	Diagnostic code	Meaning for the LMV27
201 OFF UPr	1	No operating mode selected
	2...3	No fuel train defined
	4...7	No curve defined
	8...15	Standardized speed undefined
	16...31	Backup / restore was not possible
		Other start preventions:
3	4	Air pressure ON – start prevention
4	2	Extraneous light during the startup phase- start prevention
14	64	POC open - start prevention
21	64	POC open - start prevention (software version \leq V02.00)
22 OFF S	1	Safety loop / burner flange open - prevention of startup
97	#	Error relay supervision
	0	Safety relay has welded or extraneous voltage present at the safety relay

7.5.3.4. Repetition counter

Repetition counters are available for different types of errors. They are used to set the number of errors that are permitted until lockout occurs. The last error initiates lockout. When setting the number of errors to **3**, for example, a repetition (restart) takes place after the first 2 errors, and after the third error, the LMV27 initiates lockout.



Note

Setting 16 means an infinite number of repetitions = no lockout.

Functions with adjustable repetition counter

No.	Parameter
194	Repetition limit no flame at the end of safety time 1 = no repetition 2...4 = 1...3 repetitions Recharging time: Entering into operation
196	Repetition limit air pressure failure 1 = no repetition 2 = 1 repetition 3 = 2 repetitions Recharging time: End of <i>Shutdown</i> phase
215	Repetition limit safety loop 1 = no repetition 2...15 = 1...14 number of repetitions 16 = constant repetition Recharging time: Every 24 hours
223	Repetition limit pressure switch-min gas 1 = no repetition 2...15 = 1...14 number of repetitions 16 = constant repetition Recharging time: After the <i>Operation</i> phase
240 280	Repetition limit loss of flame 1 = No repetition 2 = 1 repetition Recharging time: After the <i>Operation</i> phase

Error code	Diagnostic code	Meaning for the LMV27
2	1	No flame at the end of the first safety time
3	0	Air pressure
7	0	Loss of flame
20	0	Pressure switch-min No minimum gas / oil pressure
22 OFF S	0	Safety loop / burner flange open
85	#	Referencing error ones actuators
86	#	Error fuel actuator
87	#	Error air actuator

If the adjustable repetition counter limits are changed, the actual counter is recharged only when the associated recharging time is reached: After power-on or after a reset.



Note

If immediate recharging shall be enforced, the LMV27 can be manually locked and then reset.

Functions with fixed repetition counters

These counters cannot be set.

Meaning	Settings
	Basic setting
Number of repetitions in the event of error: <ul style="list-style-type: none"> Relay Relay control Recharging time: End of <i>Operation</i> phase	2
Number of repetition in the event of internal error Recharging time: After 24 hours of operation	5

Error code	Diagnostic code	Meaning
95...98	#	Error relay supervision
99...100	#	Internal error relay control

7.5.3.5. Start without prepurging (as per EN 676)

When using valve proving and 2 fuel valves of class A, prepurging is not required (conforming to EN 676).

Prepurging can be deactivated per parameter.

No.	Parameter
222	Gas: Prepurging 1 = active 0 = inactive

When prepurging is activated, it is performed in accordance with the adjusted prepurge time.

If not activated, it is nevertheless performed if one or several of the following conditions apply:

- Alterable lockout position
- After an off time of >24 hours
- In the event of a power failure (power-on)
- In the event of shutdown due to an interruption of gas supply (safety shutdown)

No.	Parameter
225	Gas: Prepurge time

7.5.3.6. Gas shortage program

Valve proving via pressure switch-min-gas (parameter 236 = 2)

As gas pressure switch-min-gas is located between the valves, the gas shortage test cannot be made in phase 22. Instead, when performing valve proving on startup, the gas shortage test is performed at the end of the filling time (end of phase 82).

With no valve proving on startup, the gas shortage test is made directly before first safety time is started (end of phase 39).

No.	Parameter
236	Gas: Input pressure switch-min 2 = valve proving (between fuel valve V1 and fuel valve V2) via pressure switch-min

Standard valve proving (parameter 236 = 1)

If the gas pressure is too low, startup will be aborted in phase 22.

No.	Parameter
236	Gas: Input pressure switch-min 1 = pressure switch-min before fuel valve V1 (default setting)
246	Gas: Gas shortage waiting time

If gas shortage occurs with the last of the parameterized number of start attempts, the system initiates lockout.

No.	Parameter
223	Repetition limit pressure switch-min-gas 1 = no repetition 2...15 = 1...14 number of repetitions 16 = constant repetition Recharging time: After the <i>Operation</i> phase

In that case, the LMV27 with gas shortage program makes a selectable number of start attempts until lockout occurs. The waiting time from one start attempt to the next is doubled each time, starting from an adjustable waiting time.

7.5.3.7. Program stop function

To simplify the burner settings in connection with commissioning and service work, the program sequence of the LMV27 can be stopped at the following positions:

- 1) Air damper in prepurge position 24
- 2) Ignition position 36
- 3) Interval 1 44
- 4) Interval 2 52

The program stops are integrated in the setting sequence when the plant is commissioned (refer to chapter *Air-fuel ratio curves – settings and commissioning*). After the initial settings, program stops can be activated on the parameter level.

No.	Parameter
208	Program stop 0 = deactivated 1 = prepurge position (phase 24) 2 = ignition position (phase 36) 3 = interval 1 (phase 44) 4 = interval 2 (phase 52)

The *Program stop* function is maintained until manually deactivated. If the LMV27 halts at one of the program stops, a message appears on the display of the AZL2.

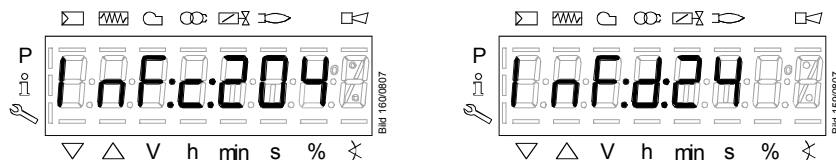

Figure 33: Message in the case of program stop

Example: **c:204** alternating with **d:24** corresponds to a program stop in the prepurge position.

7.5.3.8. Forced intermittent operation (<24 hours)

When forced intermittent operation is activated, the unit shuts down for a moment after 23 hours and 45 minutes of uninterrupted operation shutdown and followed by an automatic restart.

With the LMV27, forced intermittent operation **cannot** be deactivated.

7.5.3.9. Low-fire shutdown

To prevent the boiler from being shut down under full or nearly full load conditions, electronic air-fuel ratio control can run the burner to the low-fire position first when there is no more request for heat (refer to chapter *End of operating position*).

7.5.3.10. Continuous fan

With burners that can be damaged by heat (e.g. several burners using the same combustion chamber), continuous purging may be required. In that case, the fan operates continuously in all phases.

For that purpose, the fan motor contactor is to be connected to X3-05, pin 3, tapped after the unit fuse and the safety loop.

For checking the air pressure switch, a pressure switch relief valve must be connected to fan motor contactor X3-05, pin 1. When output X3-05, pin 1, is activated, the relief valve diverts the fan pressure to the air pressure switch and, when deactivated, ensures that no pressure is fed to the switch.

Example:

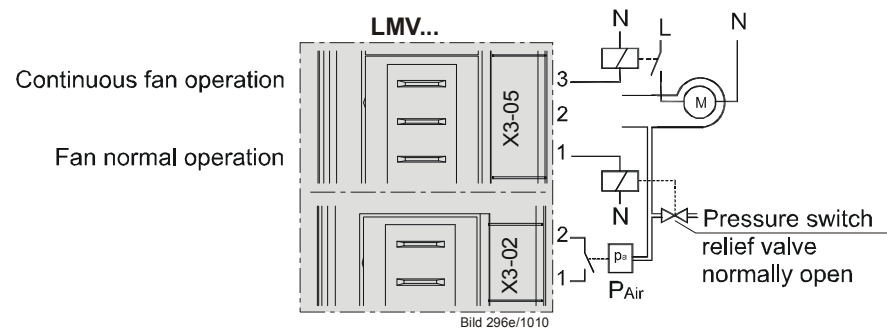

Figure 34: Continuous fan

7.5.3.11. Test function for approval of burner – loss-of-flame test (TÜV test)

The purpose of this test is to verify the detection time required in the event of loss of flame when applying for burner approval. When starting the test, the fuel valves are shut to determine the time (resolution of 0.2 seconds) until the LMV27 detects loss of flame.

Procedure:

- Determine the burner output at which the test shall be made, using parameter 133. If these parameters are not set, the test is carried out at the current output of the system
- Start the test by entering value 1 for parameter 124. If the burner's output was defined for the test (parameter 133), the LMV27 runs to that output first. To implement this function, the default value of parameter 121 (manual output) is used. This cancels any manual output that was previously active
- Now, the LMV27 shuts the fuel valves, leading to loss of flame
- The evaluation is made by the LMV27 by measuring the time the system requires from fuel valve shutdown until loss of flame is detected. Then, the required time is displayed in the form of diagnostic code **C:7** (loss of flame)

The resolution is 0.2 seconds.

Example

When the display reads **C:7 D:10**, the time required from valve shutdown to detection of loss of flame is 2 seconds (**D:10** means 10 x 0.2 = 2 seconds).

When the test is successfully completed, parameter 124 is reset to **0**. If unsuccessful, a negative value is delivered for diagnostic purposes and error code **150** is entered.

- 1 = invalid phase (test only possible in phase 60) – display reads **C:150 D: 1**
- 2 = default output < minimum output – display reads **C:150 D:2**
- 3 = default output > maximum output – display reads **C:150 D:3**
- 4 = manual abortion (no error, start variable was manually reset to **0**) – display reads **C:150 D:4**
- 5 = timeout during TÜV test (no loss of flame after shutdown of valves within **50** seconds) – lockout **C:150 D:5**

Previously set output values at which the test shall be made (parameter 133) remain stored.

No.	Parameter
121	Manual output Undefined = automatic operation
124	Loss of flame test (TÜV test) starting (parameterized on 1) (switch off the fuel valves → loss of flame) Error diagnostic via negative value (refer to error code 150)
133	Default output at TÜV test Invalid = TÜV test at active output 20...100 = low-fire...high-fire or stage 1 / stage 2 / stage 3 P1...P3 = stage 1...stage 3

7.5.3.12. Postpurging in the lockout position

Parameter 190 can be used to move the actuators (actuators or VSD) to the postpurge position while they are in the lockout position.

No.	Parameter
190	Postpurging in lockout position 0 = deactivate (no-load position) 1 = active (postpurge position) When active, the <i>Alarm in the event of start prevention</i> function (parameter 210) is only possible to a limited extent!



Note!

The LMV27 simply moves the actuators (actuators or VSD) to the postpurge position. A fan or VSD release contact cannot be controlled, as the alarm relay of the LMV27 cuts off the power supply to the outputs. With the *Alarm in the event of start prevention* function, an external circuit that may be present for controlling the fan / VSD release contact for postpurging in the lockout position is activated via start prevention in standby mode.

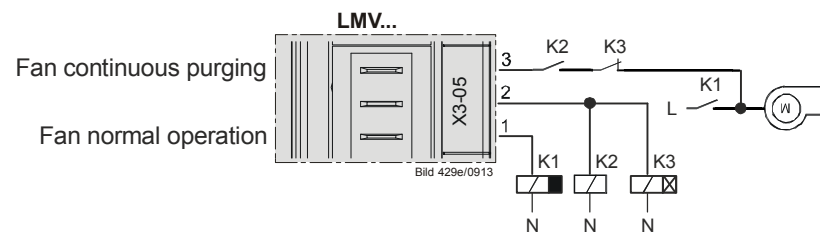

Figure 35: Application example of postpurging in the lockout position with fan but without VSD

The duration of postpurging in the lockout position can be set via the delay time of K3.



Attention!

When the *Postpurging in the lockout position* function is used, the fan may only be powered via a contactor and must not be connected directly to LMV2 (X3-05 pin 1)!

7.6 Fuel trains (application examples)

Gas direct ignition

(Operating mode 1, 7, 14, 19, 28)

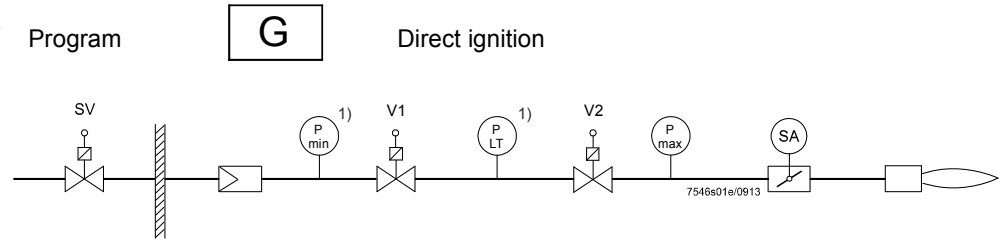

Figure 36: Gas direct ignition

Gas pilot ignition 1

(Operating mode 2, 8, 15, 20)

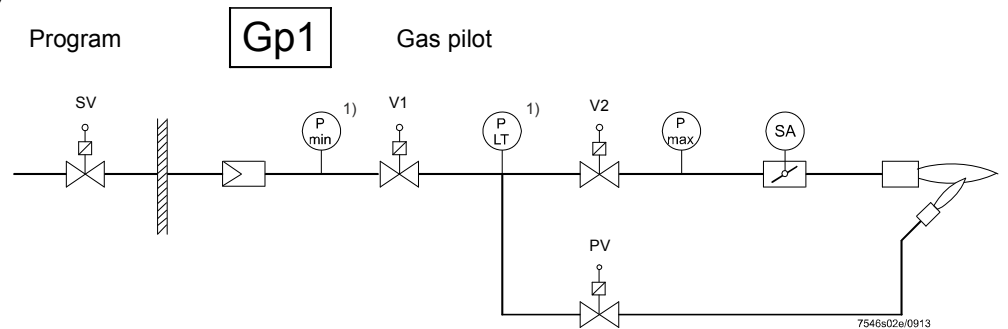

Figure 37: Gas pilot ignition 1

Gas pilot ignition 2

(Operating mode 3, 9, 16, 21, 29)

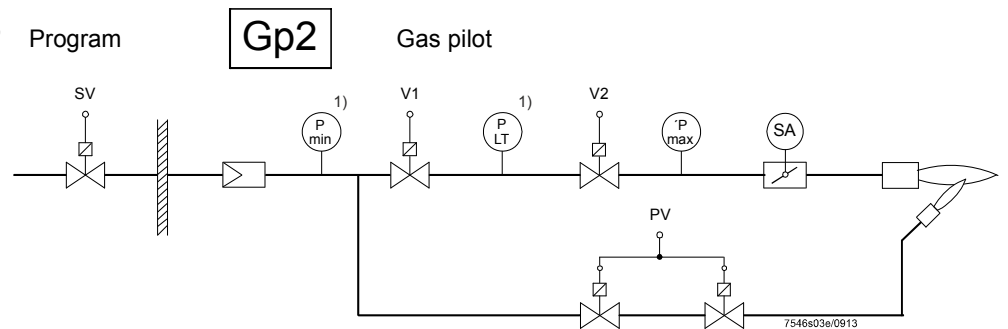

Figure 38: Gas pilot ignition 2

Legend for fuel trains:

*) Not used

1) 1) For the valve proving function, the pressure switch-min is located between the fuel valve V1 / V2

- LO Light oil
- No Normally Open
- P LT Valve proving
- Pmax Pressure switch-max
- Pmin Pressure switch-min
- PV Pilot valve
- SA Actuator
- SV Safety valve (outdoors)
- TSAx Safety time
- V Fuel valve

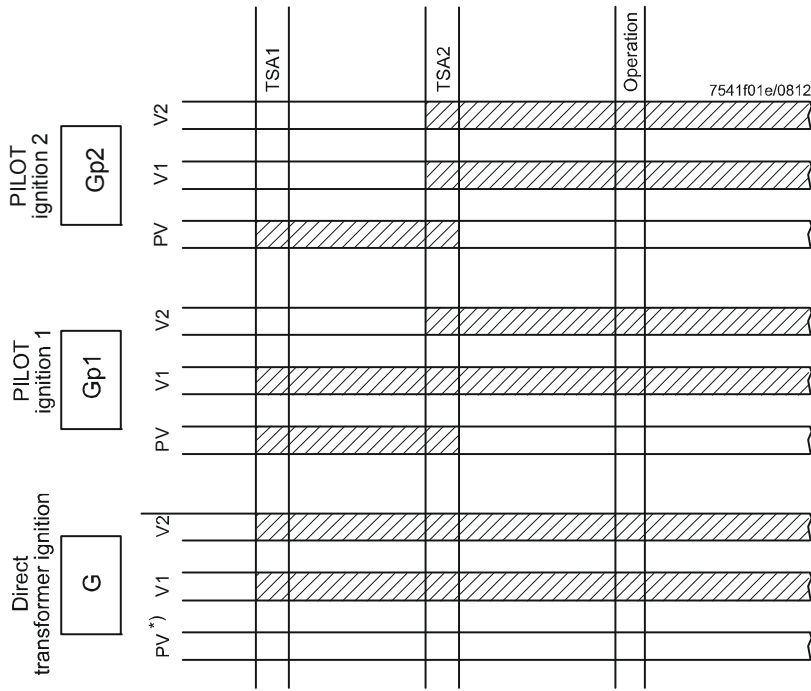
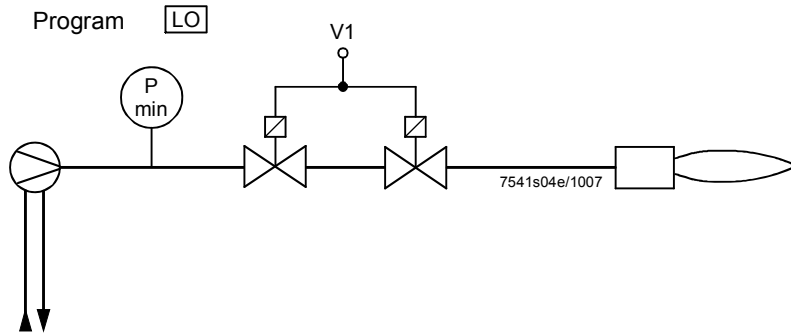

Figure 39: Gas trains – fuel valve control

Light oil direct ignition,
multistage
(Operating mode 5, 17)

1-stage burner



(Operating mode 5, 17)

2-stage burner

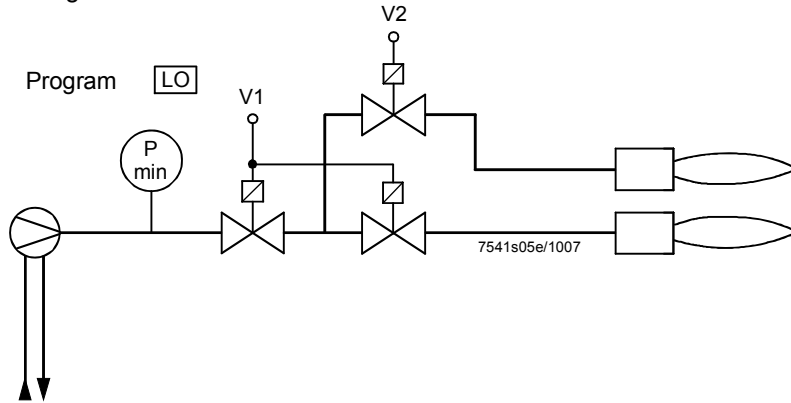

(Operating mode 6, 18)

3-stage burner

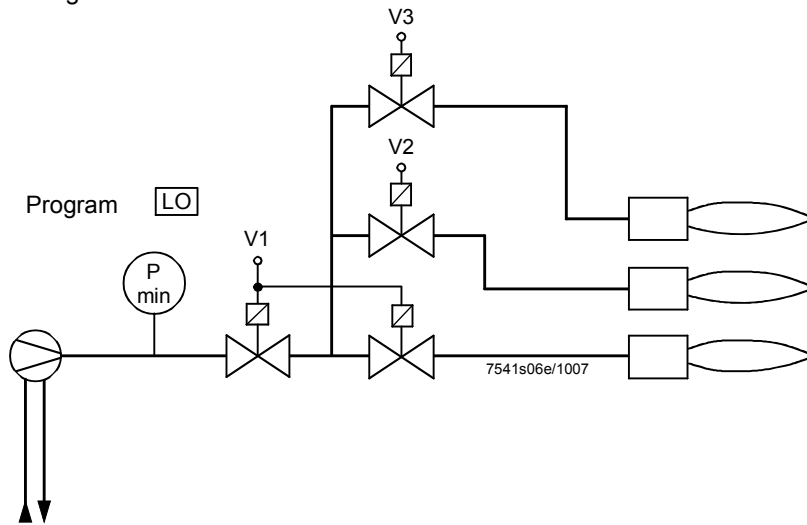

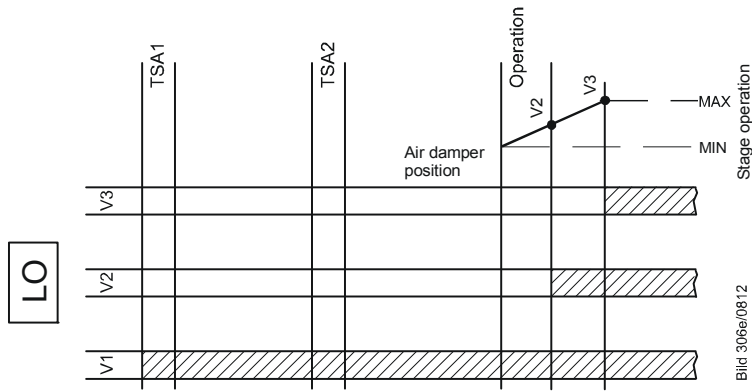

Figure 43: Light oil - direct ignition stage - fuel valve control

Legend for fuel trains:

- LO Light oil
- No Normally Open
- LK Air damper
- P LT Valve proving
- Pmax Pressure switch-max
- Pmin Pressure switch-min
- PV Pilot valve
- SA Actuator
- SV Safety valve (outdoors)
- TSAx Safety time
- V Fuel valve
- Z Ignition

Light oil direct ignition,
modulating

(Operating mode 4, 22)

Modulating burner (without shutdown facility for adjustable head)

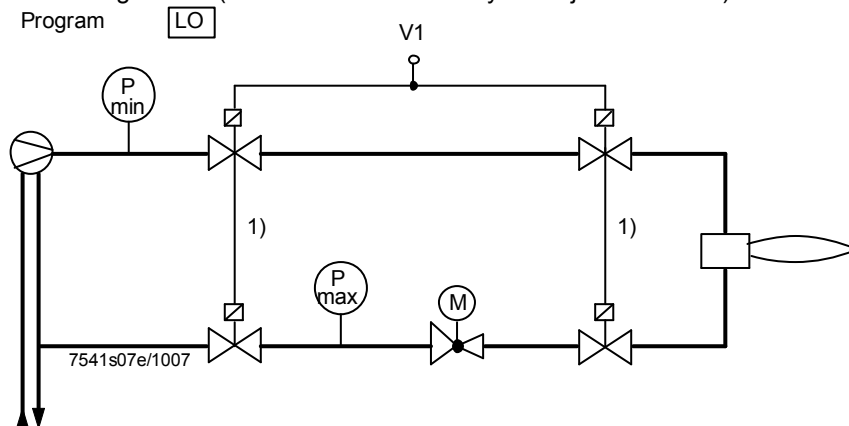

Figure 44: Light oil - direct ignition modulation

(Operating mode 4, 22)

Modulating burner (with shutdown facility for adjustable head)

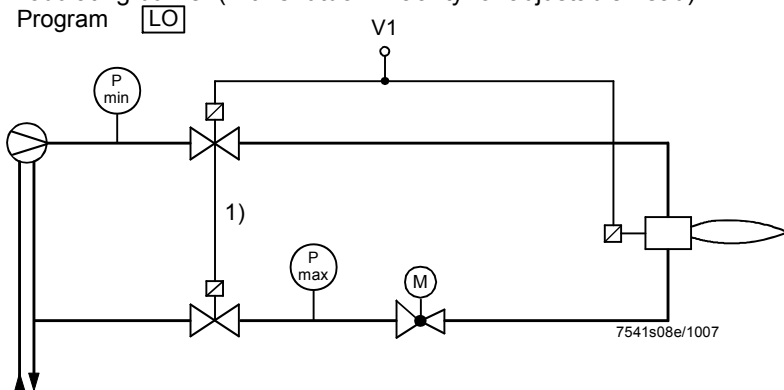

Figure 45: Light oil - direct ignition modulation

Fuel valve control

Light oil (transformer for direct ignition)

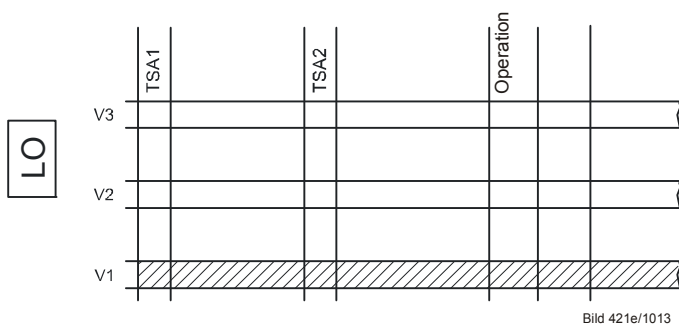

Figure 46: Light oil - direct ignition - fuel valve control

Legend for fuel trains:

- 1) Series connection of two DC 115 V valves
- LO Light oil
- No Normally Open
- LK Air damper
- P LT Valve proving
- Pmax Pressure switch-max
- Pmin Pressure switch-min
- PV Pilot valve
- SA Actuator
- SV Safety valve (outdoors)
- TSAx Safety time
- V Fuel valve
- Z Ignition

Light oil direct ignition
modulating with 2 fuel valves

(Operating mode 12)

Modulating burner (without shutdown facility for adjustable head)

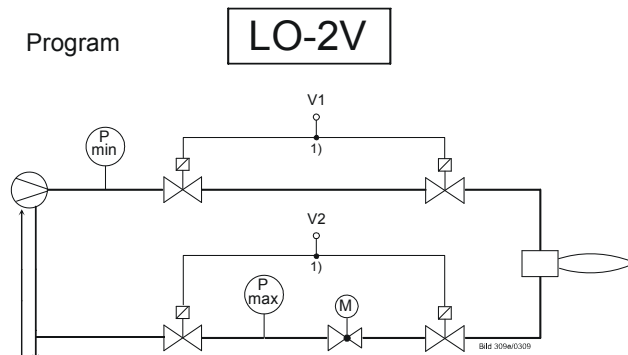

Figure 47: Light oil – direct ignition, modulating, without shutdown facility for adjustable head

(Operating mode 12)

Modulating burner (with shutdown facility for adjustable head)

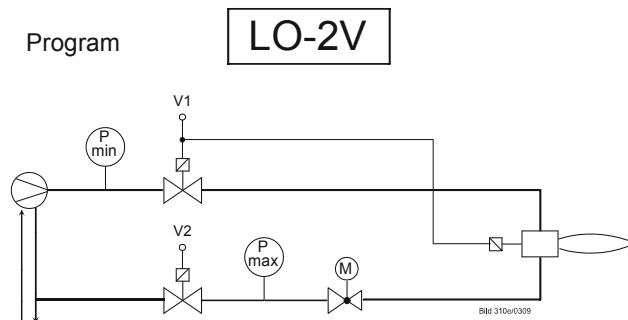

Figure 48: Light oil – direct ignition, modulating, with shutdown facility for adjustable head

Fuel valve control

Light oil (transformer for direct ignition)

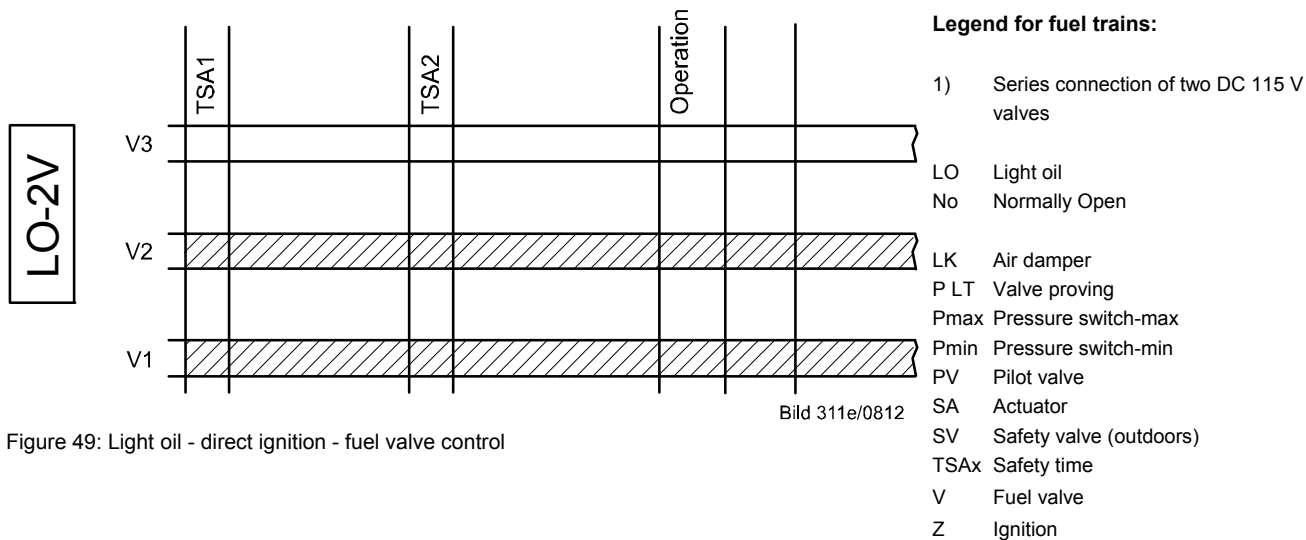

Figure 49: Light oil - direct ignition - fuel valve control

Light oil with gas pilot ignition

(Operating mode 3, 9, 16, 21)

Program

LOgp

(Operating mode 10, 11)

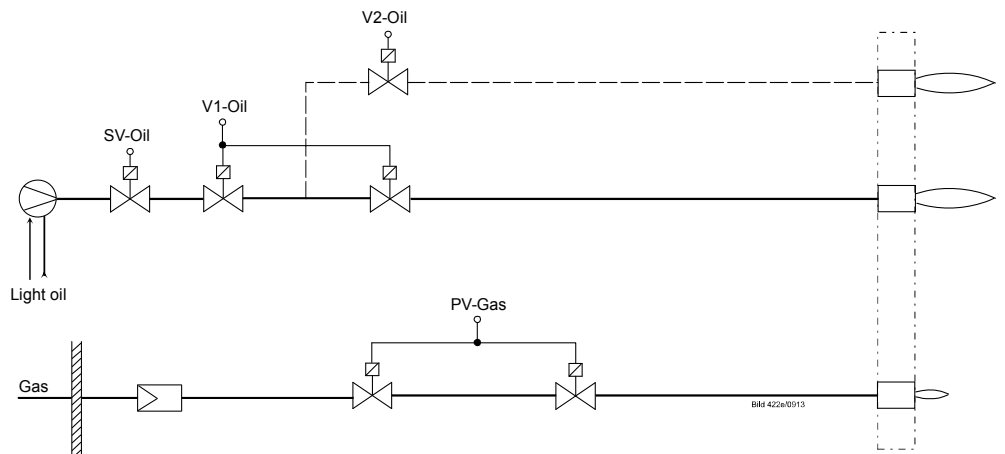

Figure 50: Light oil with gas pilot ignition

Fuel valve control

Light oil (with gas pilot ignition)

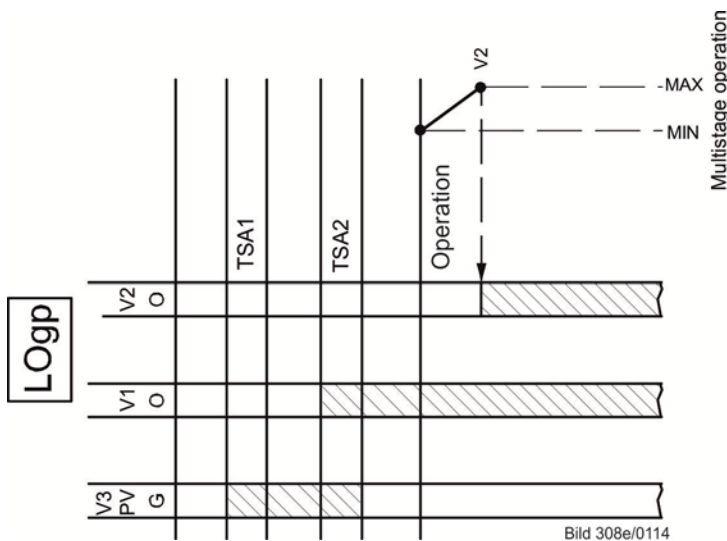

Figure 51: Light oil with gas pilot ignition – fuel valve control

Legend for fuel trains:

- LO Light oil
- No Normally Open
- LK Air damper
- P LT Valve proving
- Pmax Pressure switch-max
- Pmin Pressure switch-min
- PV Pilot valve
- SA Actuator
- SV Safety valve
(outdoors)
- TSAx Safety time
- V Fuel valve
- Z Ignition

Light oil with gas pilot ignition
with 2 fuel valves

(Operating mode 3, 9, 16, 21)

Program

LOgp-2V

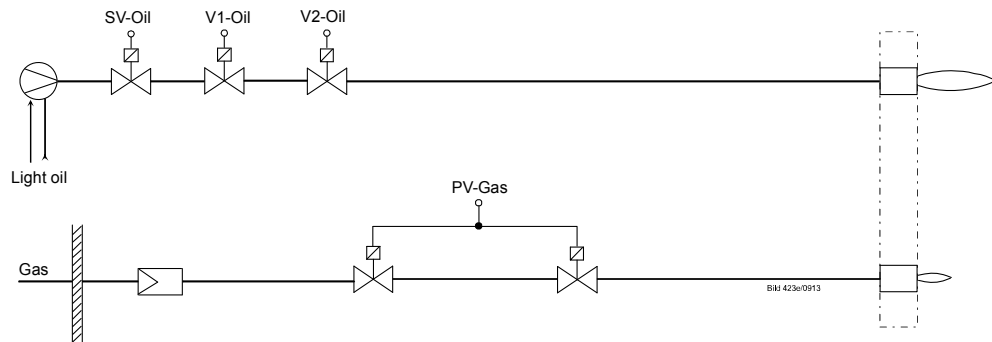

(Operating mode 13)

Figure 52: Light oil with gas pilot ignition

Fuel valve control

Light oil (with gaspilot ignition)

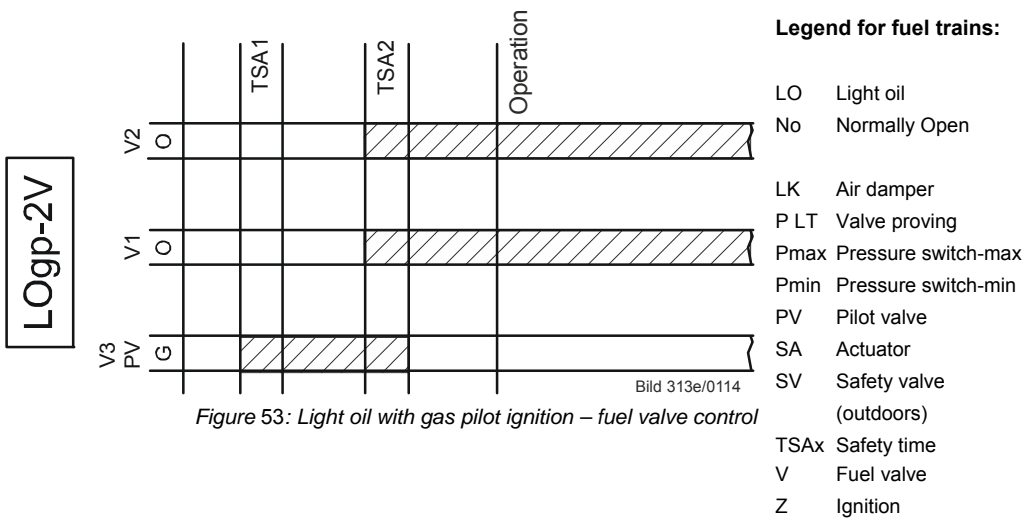

Figure 53: Light oil with gas pilot ignition – fuel valve control

7.7 Sequence diagrams

The phase numbers given in the sequence diagrams can be read from the following process data:

No.	Parameter
961	Phase (state of external module and display)

7.7.1 Gas direct ignition «G», «G mod», «G mod pneu»

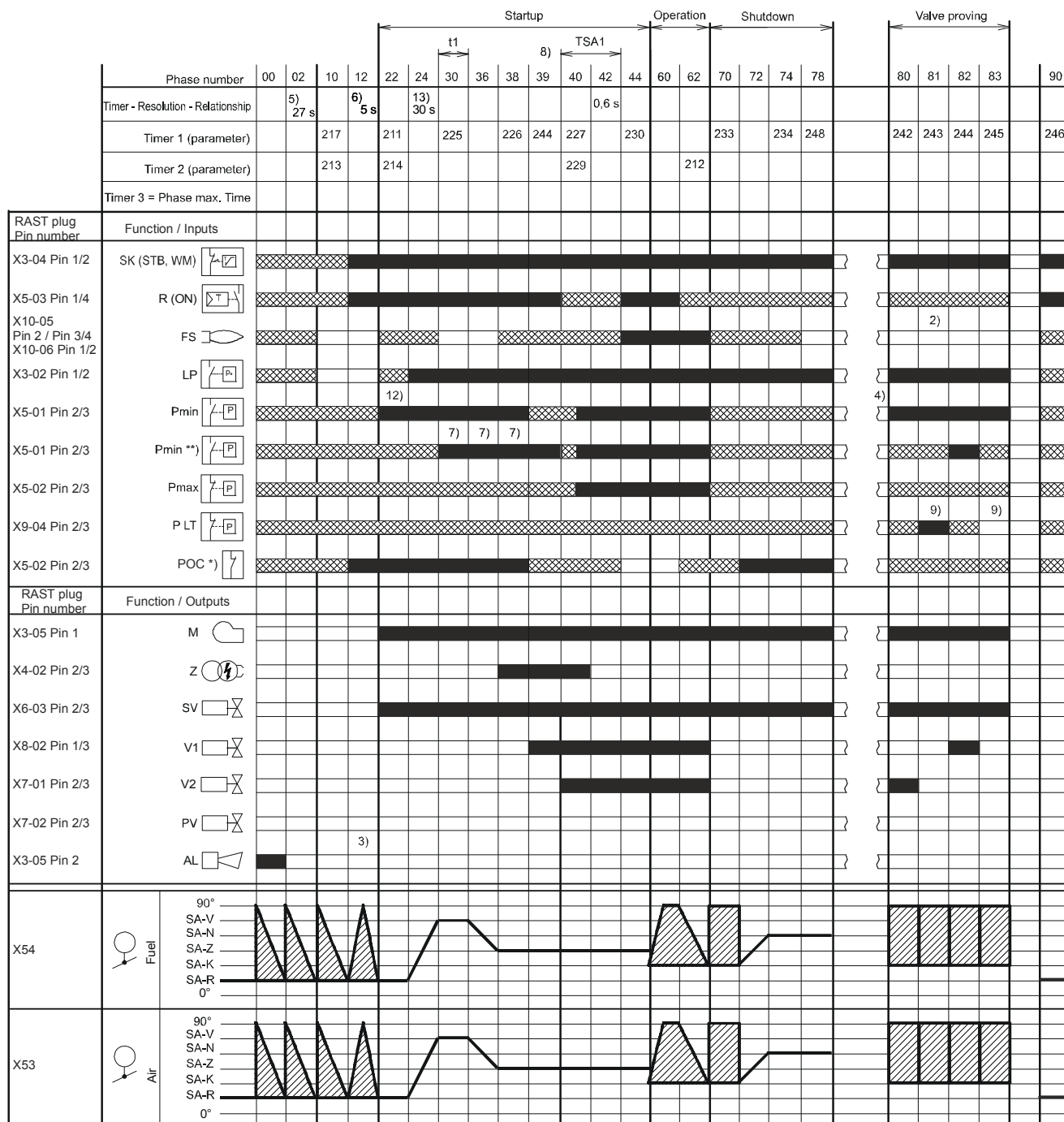

Figure 54: Program for gas direct ignition (G)/(G mod)/(G mod pneu)

Bild 08e/1013

7.7.2 Gas pilot ignition 1 «Gp1», «Gp1 mod», «Gp1 mod pneu»



Bild 10e/1013

Figure 55: Program for gas pilot ignition (Gp1)/(Gp1 mod)/(Gp1 mod pneu)

7.7.3 Gas pilot ignition 2 «Gp2», «Gp2 mod», «Gp2 mod pneu»

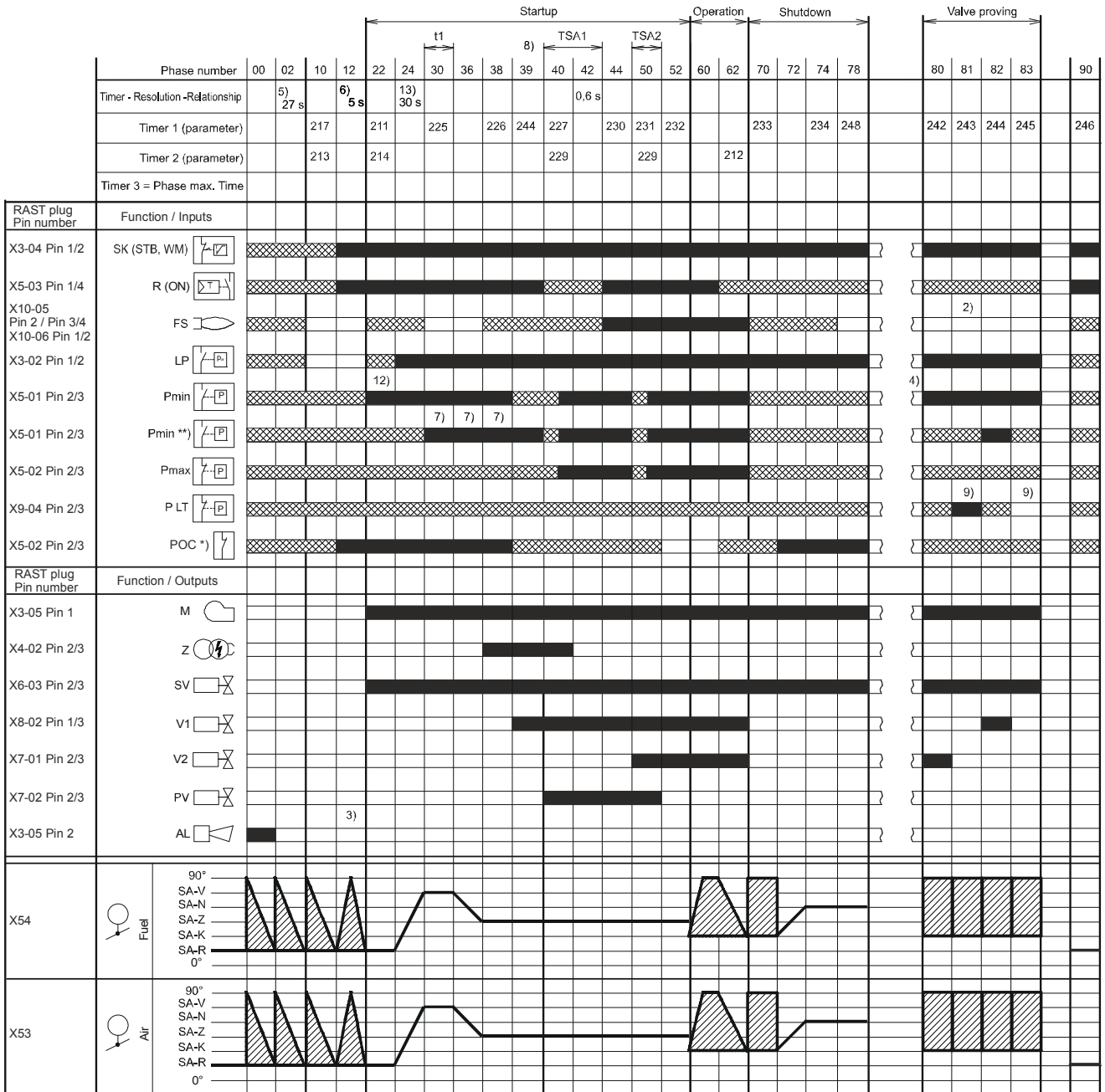

Bild 12e/1013

Figure 56: Program for gas pilot ignition (Gp2)/(Gp2 mod)/(Gp2 mod pneu)

7.7.4 Light oil direct ignition «Lo», «Lo mod», «Lo 2 stage», « Lo 3-stage»

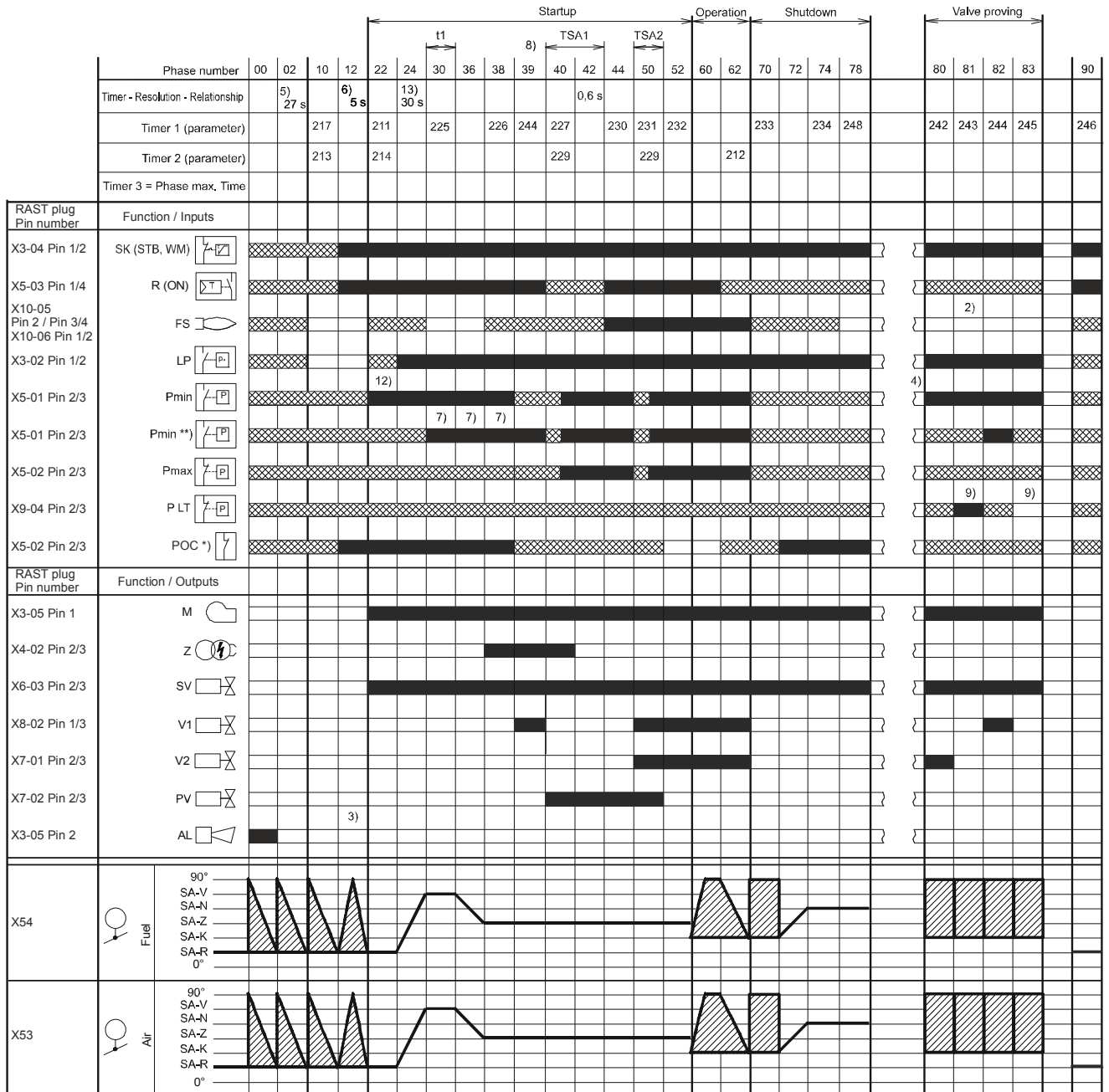

Bild 04e/1010

Figure 57: Program for light oil direct ignition (Lo)/(Lo mod)/(Lo 2-stage)/(Lo 3-stage)

7.7.5 Light oil – pilot ignition «LoGp» «LoGp mod» «LoGp 2-stage»

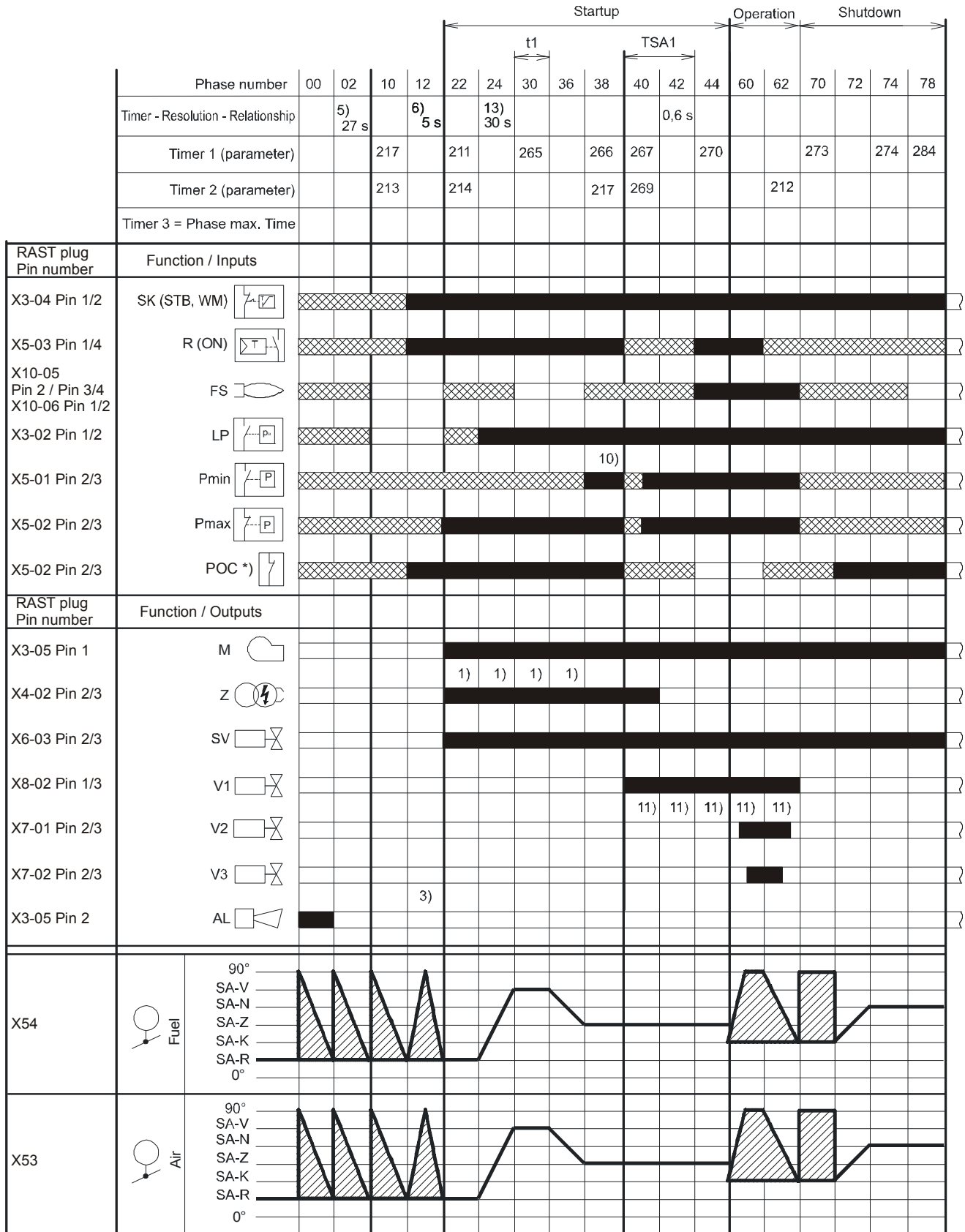

Bild 20e/1013

Figure 58: Program light oil – pilot ignition «LoGp» «LoGp mod» «LoGp 2-stage»

7.7.6 Legend to the sequence diagrams

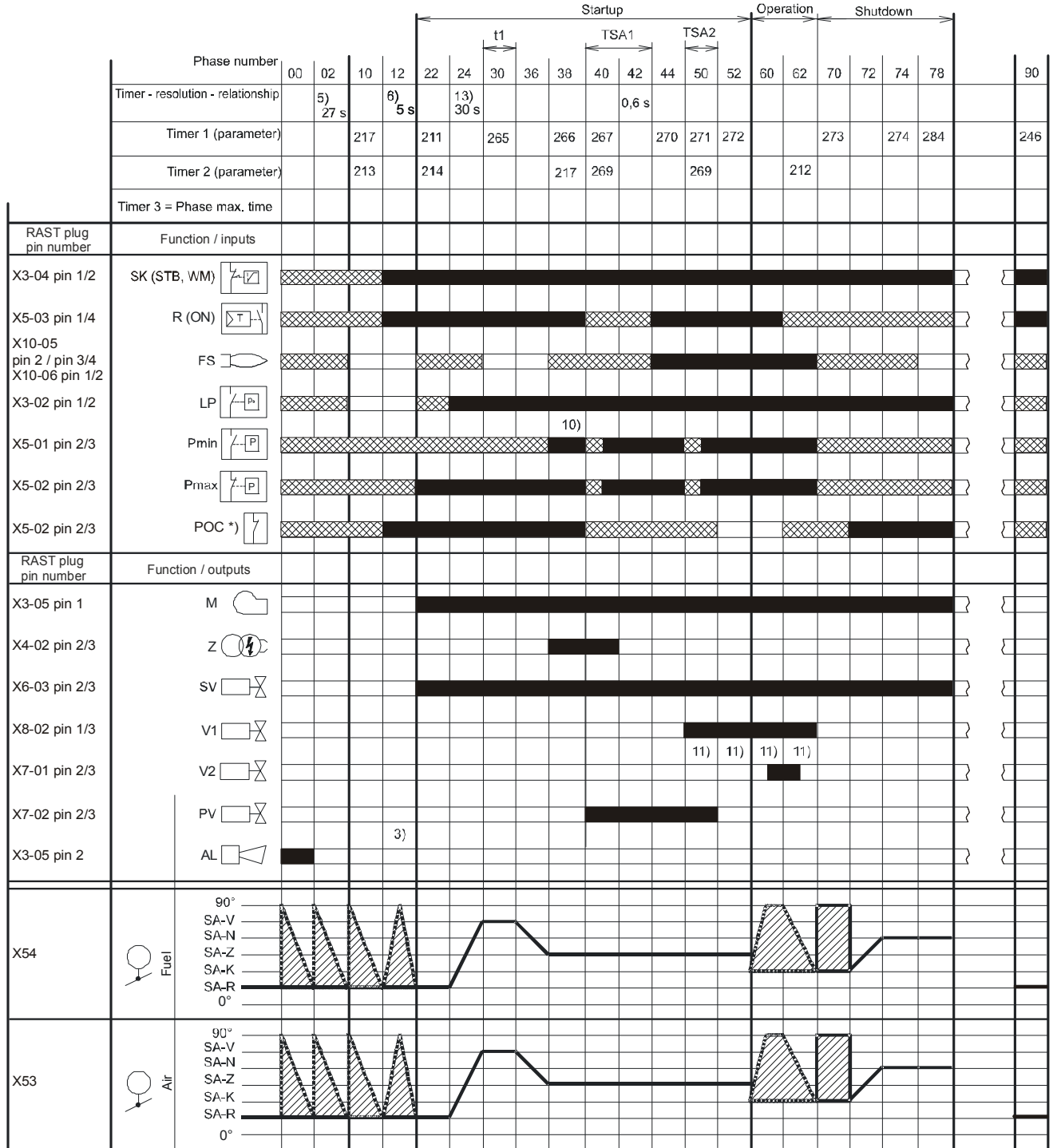

Note

Not all phases, times, indices, abbreviations and symbols appear in the individual sequence diagrams or are needed there!

Phase numbers

00	Lockout phase
02	Safety phase
10	Home run
12	Standby (stationary)
22	Fan motor = ON, safety valve = ON
24	Air damper ⇒ pre purge position
30	Prepurging
35	Fan ⇒ ignition speed
36	Air damper ⇒ ignition position
38	Preignition ignition = ON
39	Test pressure switch-min
40	Fuel valve = ON
42	Ignition = OFF
44	Interval 1
50	Second safety time
52	Interval 2
60	Operation 1 (stationary)
62	Operation 2 (air damper ⇒ low-fire position)
70	Afterburn time
71	Fan ⇒ postpurge speed
72	Air damper ⇒ Rated load position
74	Postpurge time
78	Postpurge time
79	Fan ⇒ standby speed
80	Evacuation of test space
81	Test time atmospheric pressure
82	Filling of test space
83	Test time gas pressure
90	Gas shortage waiting time

Valve proving is performed depending on the parameter settings:
Simultaneously with the prepurge time **and/or** the afterburn time.

Times

TSA1	1st safety time
TSA2	2nd safety time
t1	Prepurge time
t3	Postpurge time
t8	Postpurge time
t13	Afterburn time
t44	Interval 1
t52	Interval 2

Indices

1)	Parameter:	Short/long prepurge time for oil only Short/long oil pump – ON – time
2)		Only with valve proving during startup
3)	Parameter:	With/without alarm in the event of start prevention
4)		If signal is faulty in the startup phase, phase 10 is next, otherwise phase 70
5)		Max. time safety phase, then lockout
6)		Time from occurrence of start prevention to signaling
7)		Only in case of valve proving during startup (valve proving via pressure switch-min)
8)		Only in case of startup without valve proving (valve proving via pressure switch -min)
9)		Inverse logic in case of valve proving via pressure switch-min
10)	Parameter 276:	Oil: Input oil pressure min 1 = active from phase 38 2 = active from safety time
11)		Only with fuel train <i>Lo</i> and 2 fuel valves
12)	Parameter 223:	Repetition limit value gas pressure switch-min in connection with gas shortage program parameter 246 (phase 90) 1 = no repetition 2...15 = 1...14 number of repetitions 16 = constant repetition
13)		Maximum drop-in/response time for air pressure switch
14)		Alternative to valve proving
15)		Alternative to pressure switch-max or POC

Abbreviations

AL	Alarm
FS	Flame signal
GM	Fan motor contactor
LP	Air pressure switch
M	Fan motor
P LT	Pressure switch for valve proving
Pmax	Pressure switch-max
Pmin	Pressure switch-min
POC	Proof of closure
PV	Pilot valve
R	Temperature or pressure controller
SB	Safety limiter
SK	Safety loop
STB	Safety limit thermostat
SV	Safety valve
WM	Water shortage
V1	Fuel valve V1
V2	Fuel valve V2
VP	Combustion pressure switch
Z	Ignition transformer
SA	Actuator
SA-K	Low-fire position of actuator
SA-N	Postpurge position of actuator
SA-R	Home position of actuator
SA-V	Rated load position of actuator
SA-Z	Ignition load position of actuator

Symbols



Permissible position range



In *Standby* mode: Actuator is allowed to travel within the permissible position range, but is always driven to the home position; must be in the home position for phase changes

0°/10%
90°/100%

Position as supplied (0°)
Actuator fully open (90°)



Input/output signal 1 (ON)
Input/output signal 0 (OFF)
Input permissible signal 1 (ON) or 0 (OFF)

*)

Alternative to pressure switch-max

**)

Only with valve proving via pressure switch-min

8 Selection of operating mode

To facilitate straightforward adaptation of the LMV27 to different types of burners, the LMV27 offers automatic configuration of the operating mode. This means that – derived from parameter 201 – the most important settings relating to the operating mode are made automatically. Very often in that case, the only manual settings to be made are those for the air-fuel ratio control system. After selection of the operating mode, parameters that are not required will be hidden (e.g. oil parameters when firing on gas).

No.	Parameter
201	Burner operating mode (fuel train, modulating / multistage, actuators, etc.) -- = undefined (delete curves) 1 = G mod 2 = Gp1 mod 3 = Gp2 mod 4 = Lo mod 5 = Lo 2-stage 6 = Lo 3-stage 7 = G mod pneu 8 = Gp1 mod pneu 9 = Gp2 mod pneu 10 = LoGp mod 11 = LoGp 2-stage 12 = Lo mod 2 fuel valves 13 = LoGp mod 2 fuel valves 14 = G mod pneu without actuator 15 = Gp1 mod pneu without actuator 16 = Gp2 mod pneu without actuator 17 = Lo 2-stage without actuator 18 = Lo 3-stage without actuator 19 = G mod gas actuator only 20 = Gp1 mod gas actuator only 21 = Gp2 mod gas actuator only 22 = Lo mod oil actuator only 23 = Ho mod separate circulation control ¹⁾ 24 = Ho 2-stage separate circulation control ¹⁾ 25 = Ho mod without circulation control ¹⁾ 26 = Ho 2-stage without circulation control ¹⁾ 27 = Ho 3-stage without circulation control ¹⁾ 28 = G mod mech air actuator only ¹⁾ 29 = Gp2 mod mech air actuator only ¹⁾
	¹⁾ Selected operating mode is not released for the LMV27. With select: Error code 210 diagnostic code 0

Operating mode parameter 201	Fuel train	Air-fuel ratio control	Fuel actuator	Air actuator	Description
1	G mod	Modulating electronic	●	●	Gas direct ignition, electronic modulating ratio control.
2	Gp1 mod	Modulating electronic	●	●	Gas pilot ignition 1, electronic modulating ratio control.
3	Gp2 mod	Modulating electronic	●	●	Gas pilot ignition 2, electronic modulating ratio control.
4	Lo mod	Modulating electronic	●	●	Oil direct ignition, electronic modulating ratio control.
5	Lo 2-stage	2-stage		●	Oil direct ignition, electronic 2-stage ratio control.
6	Lo 3-stage	3-stage		●	Oil direct ignition, electronic 3-stage ratio control.
7	G mod pneu	Modulating pneumatic		●	Gas direct ignition, pneumatic modulating ratio control.
8	Gp1 mod pneu	Modulating pneumatic		●	Gas pilot ignition 1, pneumatic modulating ratio control.
9	Gp2 mod pneu	Modulating pneumatic		●	Gas pilot ignition 2, pneumatic modulating ratio control.
10	LoGp mod	Modulating electronic	●	●	Oil pilot ignition, electronic modulating ratio control.
11	LoGp 2-stage	2-stage		●	Oil pilot ignition, electronic 2-stage ratio control.
12	Lo mod 2 fuel valves	Modulating electronic	●	●	Oil direct ignition, 2 fuel valves, electronic modulating ratio control.
13	LoGp mod 2 fuel valves	Modulating electronic	●	●	Oil pilot ignition, 2 fuel valves, electronic modulating ratio control.
14	G mod pneu without actuator	Modulating pneumatic			Gas direct ignition, without actuator, pneumatic modulating ratio control.
15	Gp1 mod pneu without actuator	Modulating pneumatic			Gas pilot ignition 1, without actuator, pneumatic modulating ratio control.
16	Gp2 mod pneu without actuator	Modulating pneumatic			Gas pilot ignition 2, without actuator, pneumatic modulating ratio control.
17	Lo 2-stage without actuator	2-stage			Oil direct ignition, without actuator, electronic 2-stage ratio control.
18	Lo 3-stage without actuator	3-stage			Oil direct ignition, without actuator, electronic 3-stage ratio control.
19	G mod only gas actuator	Modulating electronic	●		Gas direct ignition, only gas actuator. modulating ratio control.
20	Gp1 mod only gas actuator	Modulating electronic	●		Gas pilot ignition 1, only gas actuator. modulating ratio control.
21	Gp2 mod only gas actuator	Modulating electronic	●		Gas pilot ignition 2, only gas actuator. modulating ratio control.
22	Lo mod only oil actuator	Modulating electronic	●		Oil direct ignition, only oil actuator. modulating ratio control.
23	Ho mod separate circulation control *)	Modulating electronic	●	●	Heavy oil direct ignition, with circulation control, electronic modulating ratio control.
24	Ho 2 stage separate circulation	2-stage		●	Heavy oil direct ignition, with circulation control, electronic 2-stage ratio control.

Operating mode parameter 201	Fuel train	Air-fuel ratio control	Fuel actuator	Air actuator	Description
	control ¹⁾				
25	Ho mod without circulation control ¹⁾	Modulating electronic	●	●	Heavy oil direct ignition, without circulation control, electronic modulating ratio control.
26	Ho 2 stage without circulation control ¹⁾	2-stage		●	Heavy oil direct ignition, without circulation control, electronic 2-stage ratio control.
27	Ho 3 stage without circulation control ¹⁾	3-stage		●	Heavy oil direct ignition, without circulation control, electronic 3-stage ratio control.
28	G mod mech only air actuator ¹⁾	Modulating mechanical		●	Gas direct ignition, only air actuator, mechanical modulating ratio control.
29	Gp2 mod mech only air actuator ¹⁾	Modulating mechanical		●	Gas pilot ignition 2, only air actuator, mechanical modulating ratio control.

¹⁾ Selected operating mode is not released for the LMV27.
With select: Error code 210 diagnostic code 0

(Also refer to chapter *Fuel trains*)

8.1 Deleting curves

To delete curves, the operating mode must be set to undefined «--». In that case, only the fuel curves are deleted, the direction of rotation or the reference position of the actuators is not changed.

9 Connection to load controllers

The LMV27 can be connected to different load controllers. Heat request and the required burner output are determined in accordance with the priorities of the different load sources.

9.1 Load controller on contact X5-03, pin 1

This contact is given priority over all load controller sources. A heat request can only be made when this contact is closed. The contact is safety-related and can also be used in connection with load controllers featuring an integrated *Temperature limiter* function.

9.2 External load controller via contacts X5-03, pin 2 / pin 3

The heat request is delivered via pin 1. Modulation of burner output is effected via pin 2 and 3. Here, a differentiation is made between modulating and multistage operation (refer to chapter *Selection of operating mode*).

Modulating operation X5-03 (OPEN pin 3 / CLOSE pin 2)

If input *Open* is active, the burner's output is increased. If input *Close* is active, the burner's output is decreased. If none of the inputs is active, the burner's output is not changed.

The rate of integration is 32 seconds for changing the output from low-fire (20%) to high-fire (100%) or vice versa (parameter 544), that means a burner output from 100% to 20%.

Output integration always takes place in the operating position.
200 ms is the shortest positioning step that is securely detected.

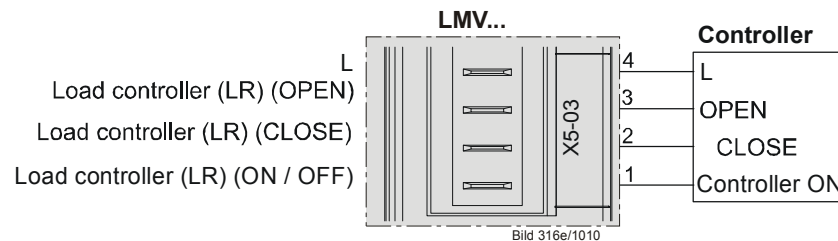

Figure 59: Modulating operation X5-03

No.	Parameter
544	Ramp modulating

Minimum positioning step

To prevent the actuators from making unnecessary position changes when the preselected target output varies, a minimum positioning step can be set. In that case, the LMV27 changes the output only when the preselected target output exceeds the minimum positioning step. This minimum positioning step is only used in modulating operation.

No.	Parameter
123.2	Minimum output positioning step: Output of external load controller contacts

Multistage operation X5-03 (stage 2, pin 3 / stage 3, pin 2)

In multistage operation, 1 or 2 thermostats can be connected to activate the different burner stages. Multistage operation is possible only when firing on oil.
 If neither input *Stage 2* nor input *Stage 3* is active, the burner switches to *Stage 1*.
 If input *Stage 2* becomes active, the burner switches to the second stage.
 If input *Stage 3* becomes active, the burner switches to the third stage. In that case, input *Stage 2* can be active or inactive. The third stage can only be activated with 3-stage operation.

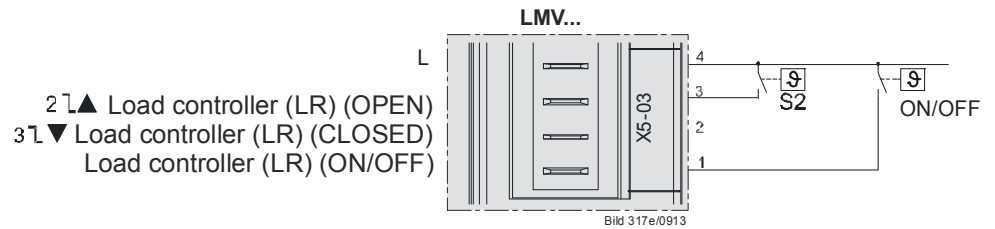

Figure 60: 2-stage operation X5-03

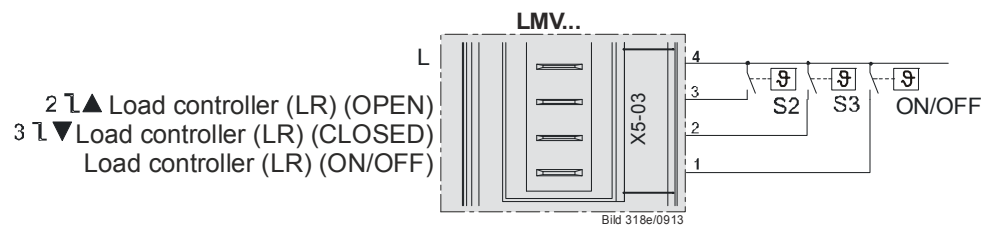

Figure 61: 3-stage operation X5-03

Shifting multistage operation (OPEN pin 3 / CLOSE pin 2)

Using a simple thermostat, a modulating burner can be operated in shifting 2-stage mode. In that case, there must be a firm connection between terminal CLOSE and the live conductor (L), and terminal OPEN must be connected to the thermostat or the load controller.

If OPEN is inactive, the active CLOSE terminal drives the burner to low-fire.

If OPEN becomes active, priority is given over terminal CLOSE so that the output is increased by driving the burner to high-fire.

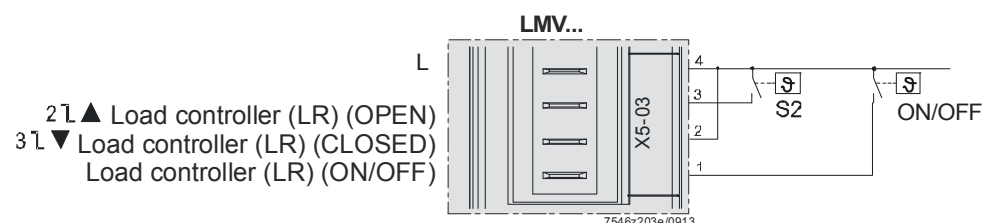

Figure 62: Shifting multistage operation (OPEN pin 3 / CLOSE pin 2)

Parameter 205 is needed to interchange usage of the load controller contacts for multistage operation. In that case, the burner switches to the third stage when input Stage 2 is active (load controller OPEN). This has no impact on modulating operation.

No.	Parameter
205	Function <i>Load controller contacts multistage</i> 0 = standard 1 = stages interchanged

Modulating		Standard	Stages interchanged
X5-03 pin 1	ON / OFF	Low-fire	Low-fire
X5-03 pin 2	Close	Signal Close	Signal Close
X5-03 pin 3	Open	Signal Open	Signal Open
2-stage		Standard	Stages interchanged
X5-03 pin 1	ON / OFF	Stage 1	Stage 1
X5-03 pin 2	Close	Stage 2	Stage 1
X5-03 pin 3	Open	Stage 2	Stage 2
3-stage		Standard	Stages interchanged
X5-03 pin 1	ON / OFF	Stage 1	Stage 1
X5-03 pin 2	Close	Stage 3	Stage 2
X5-03 pin 3	Open	Stage 2	Stage 3

9.3 Default output via building automation – X92

To control the LMV27, the BAC system can predefine an output via a bus system. The Building automation is connected to the LMV27 via the X92 interface.

Burner startup can take place only when contact X5-03 pin 1 is closed (load controller On / Off).

For more detailed information about the connection of BAC systems to LMV27, refer to chapter *Connection to superposed systems* in this document and to the *Modbus User Documentation (A7541)*.

Minimum positioning step

To avoid unnecessary positioning steps of the actuators when the predefined target output varies, a minimum positioning step can be set. The LMV27 changes the output only if the change in target output exceeds the minimum positioning step. The minimum positioning step only becomes active in modulating operation.

No.	Parameter
123.0	Minimum output positioning step: Output building automation

Behavior in the event the building automation and control system fails

If the LMV27 receives no more data from building automation, it delivers the output set via parameter 148. The time that elapses until communication breakdown is detected can be set via parameter 142.

No.	Parameter
142	Setback time in the event of communication breakdown Setting values 0 = deactivate 1...7200 s
148	Predefined output in the event of communication breakdown with building automation Setting values: For modulating operation , the setting range is as follows: 0...19.9 = burner off 20...100 = 20...100% burner output (20 = low-fire position) For multistage operation , use the following settings: 0 = burner OFF P1...P3 = stage 1...stage 3 Invalid = no output predefined by the building automation in the event of communication breakdown Default setting: <i>Invalid</i>

Setting choices:

- a) Set default output via parameter 148 to undefined (--)
In the event communication breaks down, the last valid preselected output is maintained. The next load controller activated in accordance with the priority (refer to chapter *Prioritization of load controller sources*) ensures control from this output position.
- b) Set default output via parameter 148 to 0, 20...100% or multistage
If communication breaks down, the output requested by building automation becomes invalid and the output set via parameter 148 is delivered.



Note

In that case, outputs via load controllers having a priority lower than building automation cannot be delivered.

9.4 Manual output

A manual output can be set with the *Normal display* of the AZL2 or via the ACS410 PC software.

Manual output via the AZL2

Manual output can be activated or adjusted by pressing the **F** button for at least 1 second and by pressing the **+** or **-** button.

Output **0** means *Manually OFF*.

As long as the manual output is active, the output appearing on the normal display flashes.

To deactivate and to change to automatic operation, press **ESC** for 3 seconds.

If *Manually off* is activated, it is stored via mains OFF.

On power return, the burner assumes the *Manually off* position (**OFF** flashing) (refer to chapter *Operation*).

Activation of *Manually off* in operation

To activate *Manually OFF*, first run the system to the minimum output limit. Then, press the **F** button for at least 1 second and press the **-** button.

Manually OFF is activated by releasing and pressing again the **F** button and pressing the **-** button.



Caution!

***Manually OFF* must not be used just to put a burner out of operation when doing mounting work, or when the burner is not ready for operation. The safety notes contained in chapter *Safety notes* must be observed!**

Manual output via the ACS410 PC software

Refer to description of the ACS410 PC software, Software Document (J7352).

9.5 Output with curve settings

To set the curves via the AZL2 or the ACS410 PC software, a special parameterization output is provided. Using this output, it is also possible to approach the point of ignition. The output is delivered automatically and cannot be set manually. It is only mentioned here for the sake of completeness.

9.6 Prioritization of load controller sources

To simplify the LMV27's configuration, the load controller source must be selected. The LMV27 automatically detects the available load sources and selects them. If several load controller sources are connected, they are selected according to the following priorities:

Parameter 942	Priority	Active load controller source
	1 highest	Chapter <i>Load controller ON-contact X5-03, pin 1</i> When the input is activated, the other load controller sources are assessed according to their priorities. When the input is deactivated, the burner is off
1	2	Chapter <i>Load output with curve settings</i>
2	3	Chapter <i>Manual output</i>
3	4	Chapter <i>Load controller via building automation X92</i>
5	6 lowest	Chapter <i>External load controller via contacts X5-03, pin 2 / pin 3</i>

The active load controller source can be read out via parameter 942.

No.	Parameter
942	Active load source 1 = output during curve settings 2 = manual output 3 = default output via building automation 4 = default output via analog input 5 = external load controller via contacts

9.6.1 Emergency operation with several load controller sources

By making use of the prioritization described above, it is also possible to implement emergency operation.

Should the building automation fail, the LMV27 (provided parameter 148 is set to undefined (--)), switches automatically over to the external load controller.

No.	Parameter
148	Predefined output in the event of communication breakdown with building automation Setting values: For modulating operation , the setting range is as follows: 0...19.9 = burner off 20...100 = 20...100% burner output (20 = low-fire position) For multistage operation , use the following settings: 0 = burner OFF P1...P3 = stage 1...stage 3 Invalid = no output predefined by the building automation system in the event of communication breakdown Default setting: <i>Invalid</i>

9.6.2 Manual control

If the external load controller via contacts is not used, it is possible to change to manual output via the switch for switching from automatic to manual operation; this cuts the connection to the load controller.

In that case, the LMV27 switches to the external load controller via contact.

A switch for Open/Close or stage 2/stage 3 can then be connected to the load controller's terminals.

10 Electronic air-fuel ratio control

10.1 General

Electronic air-fuel ratio control is used to control the burner's actuators depending on burner output. It is possible to connect 2 actuators.

Resolution is 0.1° with the actuators. Output can be regulated in increments of 0.1% in modulating mode and with a maximum of 3 stages in multistage mode.

To reduce the electric power required for the actuators, they are never operated simultaneously, but in successive order, or alternately.

10.2 Behavior outside the operating positions

Outside their operating positions, the actuators approach the different positions in successive order.

The program phase determines the position to be approached.

10.2.1 Traveling speed

The running speed of the actuators is fixed at 5 seconds for a positioning angle of 90° for SQM33.4, SQM33.5, and SQN1.

The speed is 10 seconds for a positioning angle of 90° for SQM33.6.

The SQM33.7 requires 17 seconds for a positioning angle of 90°.

The setting also applies to the running position (refer to chapter *Running position*).

10.2.2 Home position

This position is approached in the *Home run* (10), *Standby* (12) and *Lockout position* (00) phases.

The position can be set via the following parameters:

Parameter	Actuator
501.00	Home position fuel actuator
502.00	Home position air actuator

10.2.3 Prepurging

This position is approached in phase *Traveling to prepurging* (24).

The position can be set via the following parameters:

Parameter	Actuator
501.01	Prepurge position fuel actuator
502.01	Prepurge position air actuator

No.	Parameter
222	Gas: Prepurging 0 = inactive 1 = active
262	Oil: Prepurging 0 = inactive 1 = active

10.2.4 Ignition

The ignition position is approached in phase *Traveling to the ignition position* (38). The position is set via curve parameterization under **P0**. In modulating operation, this point is assigned to an output of 10%.

10.2.5 Postpurging

This position is approached in phase *Traveling to postpurging* (72).

The position can be set via the following parameters:

Parameter	Actuator
501.02	Postpurge position fuel actuator
502.02	Postpurge position air actuator

10.3 Modulating operation

In modulating mode, it is possible to operate 2 actuators. The burner's output can be regulated between 20.0% (low-fire) and 100.0% (high-fire) in increments of 0.1%. Since the actuators are never allowed to operate simultaneously, the output is increased in small steps of 1%. In the case of an operating ramp of 20% after 100% in 32 seconds, this represents 1 step in 400 ms. Within such an output step, the air actuator is operated in the first 200 ms, and the fuel actuator in the second 200 ms.

10.3.1 Definition of curves

The air-fuel ratio curves are defined by 10 curvepoints that are fixed and distributed across the output range.

The following assignment applies:

Curvepoint	Output	Meaning
P0	10%	Point of ignition, not approached in the operating position
P1	20%	Low-fire
P2	30%	
P3	40%	
P4	50%	
P5	60%	
P6	70%	
P7	80%	
P8	90%	
P9	100%	High-fire

The actuator positions can be set with a resolution of 0.1°.

Between the curvepoints, the positions are interpolated in a linear manner.

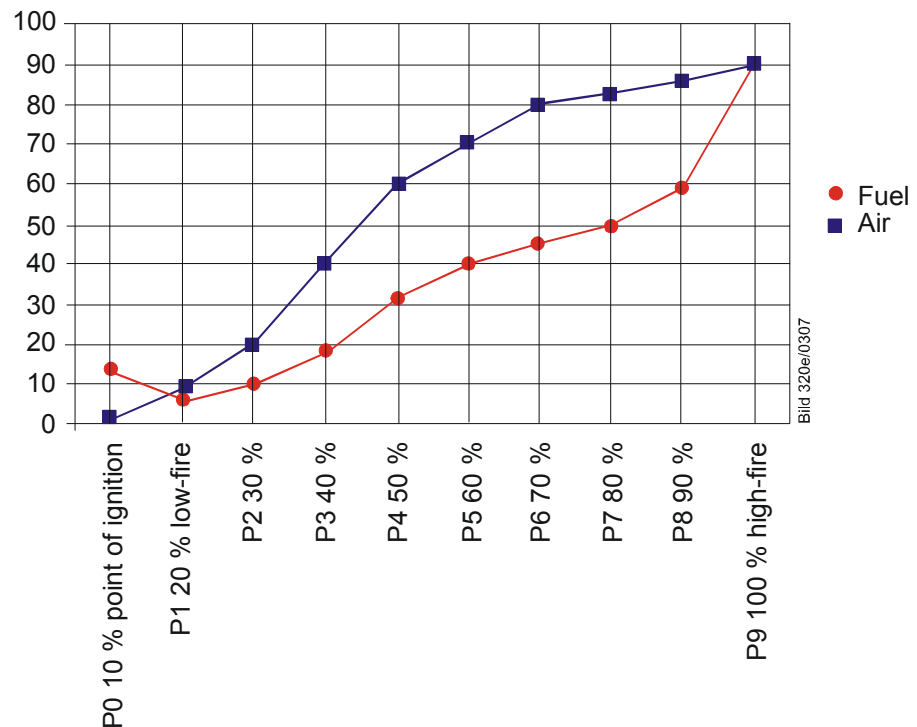

Figure 63: Definition of curves

No.	Parameter
401	Ratio control curve fuel actuator (only curve setting)
402	Ratio control curve air actuator (only curve setting)

10.3.2 Traveling speed/maximum curve slope

The time required to modulate from low-fire to high-fire can be set via parameter 544.

The following maximum curve slopes (positioning angle) can be achieved depending on the set ramp-up time (parameter 544):

Type of actuator	Positioning speed	Modulation 32 s	Modulation 48 s	Modulation 64 s	Modulation 80 s
		Positioning angle ²⁾	Positioning angle ²⁾	Positioning angle ²⁾	Positioning angle ²⁾
Actuators (3 Nm)	5 s / 90°	31°	46°	62°	77°
Actuator SQM33.6	10 s / 90°	15°	22°	30°	37°
Actuator SQM33.7	17 s / 90°	9° ¹⁾	13°	18°	22°

¹⁾ Depending on the setting, the restriction of the maximum positioning angle does not permit the maximum position of 90° to be reached

²⁾ Maximum difference between 2 curve points

No.	Parameter
544	Ramp modulating

The setting also acts outside the running position (refer to chapter *Running speed*).

Error code	Diagnostic code	Meaning for the LMV27
84	Bit 1 Valency 2..3	Fuel actuator: Curve too steep in terms of ramp speed
	Bit 2 Valency 4..7	Air actuator: Curve too steep in terms of ramp speed

The setting also acts outside the operating position (refer to chapter *Traveling speed*).

10.3.3 Entering the running position

The burner is ignited when ignition position **P0** is reached. When entering operating phase **60**, the actuators follow the defined curves until the low-fire position is reached (20% or parameter 545).

No.	Parameter
545	Lower output limit undefined = 20 %

10.3.4 Operating position

As demanded by the load controller, the actuators are driven along the defined 20% and 100% curves. Point of ignition **P0** can only be reached via the curve settings.

10.3.5 Limitation of modulation range

If the modulation range shall be further restricted from 20 to 100% against the defined curve, 2 parameters are available to define a new low-fire and high-fire position.

No.	Parameter
545	Lower output limit undefined = 20 %
546	Upper output limit undefined = 100 %

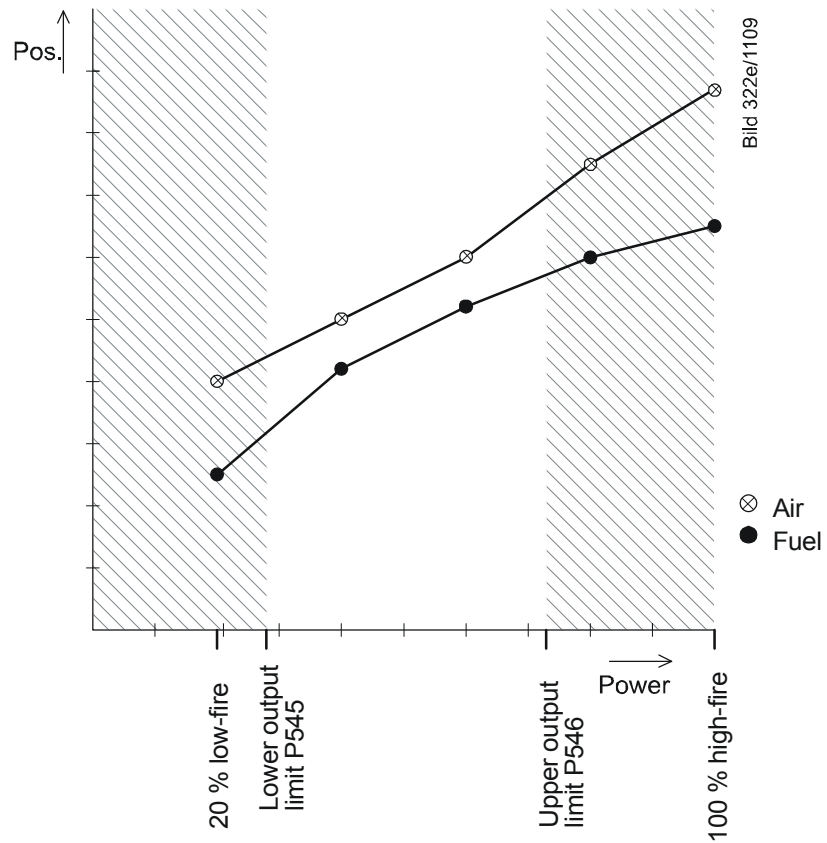

Figure 64: Restriction of modulation range

10.3.6 Setting the minimum and maximum output

When changing the setting of minimum and maximum output after making the curve settings, following is to be observed:

After leaving the curve settings with completely defined curvepoints, proceed in modulating operation by setting the minimum / maximum output (parameter 546).

In the case of *warm settings*, the parameterized output remains active until the minimum/maximum output setting is completed. Any change of the minimum/maximum output is adopted by the parameterized output. Automatic operation becomes active only after leaving the minimum/maximum output.

This procedure ensures that the LMV27 maintains the output set by the user, thus facilitating **troublefree** setting of the minimum/maximum output.

Benefits:

- The current output always corresponds to the minimum / maximum output presently parameterized, or to the system output of the curve settings made last, which means that the output can be ascertained accurately and free from interference
- The load sources of low priority (contacts, analog input, power output of the building automation system, manual output) are deactivated
- During the curve and the subsequent minimum/maximum output settings, the *Manual OFF* function is deactivated
- Unambiguous and easy-to-understand behavior of the system



Note

If there is no need to limit the output, it is not necessary to set the minimum / maximum output. In that case, the undefined minimum / maximum output corresponds to a minimum output of 20% and a maximum output of 100%.

No.	Parameter
546	Upper output limit undefined = 100 %

10.4 Multistage operation

This operating mode is only available when firing on oil. There is a choice of 2-stage and 3-stage operation. Hence, the burner's output can be modulated via 2 or 3 stages. Modulation is accomplished by adjustment of the air actuator and by switching the fuel valves for adjusting the amount of fuel.

10.4.1 Definition of curves

Air-fuel ratio control is defined via the 2 or 3 static output points. To switch the valves on and off, switch-on and switch-off points must be defined.

The following assignments apply:

Curve-point	Meaning	Valve
P0	Point of ignition (not approached in the operating position)	V1
P1	Stage 1	V1
P2on	Switch-on point stage 2. When the angle exceeds this point, the fuel valve for the second stage is switched on	V1
P2_d	Presetting of point P2 with no approach	V1
P2	Stage 2	V2
P2of	Switch-off point stage 2. When the angle falls below this point, the fuel valve for the second stage is switched off	V2
P3on	Switch-on point stage 3. When the angle exceeds this point, the fuel valve for the third stage is switched on	V2
P3_d	Presetting of point P3 with no approach	V2
P3	Stage 3	V3
P3of	Switch-off point stage 3. When the angle falls below this point, the fuel valve for the third stage is switched off	V3

The actuator positions can be set with a resolution of 0.1°.

10.4.2 Traveling speed

The defined ramp speeds are used.
The setting also acts outside the running position.

The running speed of the actuators is fixed at 5 seconds for a positioning angle of 90° for SQM33.4, SQM33.5, and SQN1.

The speed is 10 seconds for a positioning angle of 90° for SQM33.6.

The SQM33.7 requires 17 seconds for a positioning angle of 90°.

10.4.3 Adjustment of output

When the output increases, the LMV27 moves from the curvepoint of stage 1 (P1) to the switch-on point of stage 2 (P2on). If the switch-on point is exceeded, the valve for the second stage is switched on. Then, the LMV27 moves to the curvepoint for stage 2 (P2). When the output decreases, the LMV27 moves from the curvepoint of stage 2 (P2) to the switch-off point of stage 2 (P2of). If this point is crossed, the valve for the second stage is switched off. Then, the LMV27 moves to the curvepoint for stage 1 (P1). In 3-stage operation, the output between stage 2 and stage 3 is adjusted analogously to 2-stage operation. As static outputs, only **P1**, **P2** and **P3** can be approached. The switch-on and switch-off points are crossed only when changing between stages. The traveling speeds are fixed. Depending on the positioning angles to be covered, air actuator does not reach the operating or switch-on / switch-off points at the same time. The valves are switched on / off only after both actuators have reached their correct positions.

When parameterizing the curves, the switch-on points can also be approached in a stationary manner. In addition, when setting the curve via $P2_d$ ($P3_d$), curvepoint P2 (P3) can be readjusted without traveling to it. In that case, the LMV27 is at the respective switch-on point. This procedure is used to reduce the operating time if there is shortage of air.

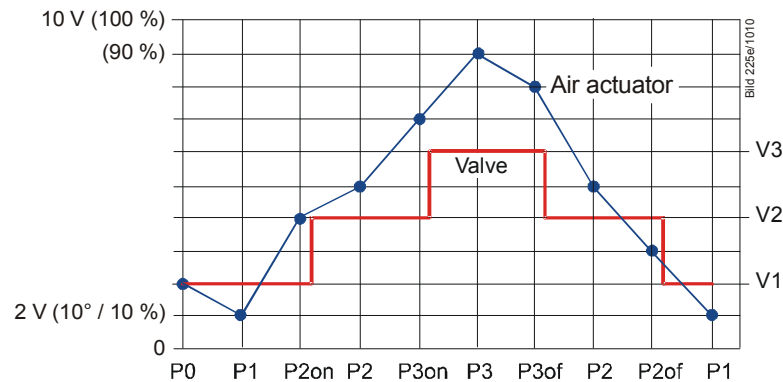

Figure 65: Adjustment of output

10.4.4 Entering the operating position

The burner is ignited at ignition position **P0**. When entering operating phase **60**, the actuators are driven from ignition position **P0** to the operating point of stage 1 (P1) at the respective traveling speed.

10.4.5 Operating position

In the operating position, the burner's output can be adjusted between operating points **P1** and **P2** or **P3** in accordance with the load controller's presetting, as described in chapter *Adjustment of output*. Ignition position **P0** is not approached anymore. It can only be reached via curve adjustment.

10.4.6 Limitation of modulation range

If the modulation range for stage 1 and stage 2, or stage 3, shall be further restricted, 2 parameters can be used to define a new low-fire and high-fire position.

No.	Parameter
545	Lower output limit undefined = 20 %
546	Upper output limit undefined = 100 %

10.5 End of operating position

When there is no more heat request, the LMV27 switches to phase 62. Here, the burner runs down to low-fire as long as possible before the valves are shut.

The available period of time can be set via parameter 212. If this time is set to the minimum value, the burner is immediately shut down if there are no more requests for heat. If the time exceeds 32 seconds, the burner always runs to low-fire. Naturally, it is also possible to set intermediate times.

No.	Parameter
212	Max. time down to low-fire

10.6 Notes on settings and parameter settings

- When making the settings for the electronic air-fuel ratio control system integrated in the LMV27, it must be ensured that sufficient amounts of excess air are available because over a period of time, the flue gas values are impacted by a number of factors, such as air density, wear of actuators and controlling elements, etc.). For this reason, the flue gas values initially set must be checked at regular intervals
- To safeguard against accidental or unauthorized transfer of parameters from the parameter backup of the ACS410 to the LMV27, the OEM (burner or boiler manufacturer) must enter an **individual burner identification** for every burner. Only when this requirement is satisfied does the LMV27 make certain that the ACS410 does not transfer a parameter set from a plant (with unsuited and possibly dangerous parameter values) to the LMV27
- With the LMV27, it should be noted that the LMV27 characteristics are determined primarily by the parameter settings and not so much by the type of unit. This means that – among other considerations – the parameter settings must always be checked prior to commissioning the plant, and that the LMV27 must never be transferred from one plant to another without adapting its parameters to the new plant
- When using the ACS410 PC software, the safety notes given in the relevant Operating Instructions (CC1J7352) must also be observed
- The parameter level is password-protected. The OEM assigns individual passwords to the parameter levels he can access. The unit is supplied with default passwords entered by Siemens; they must be changed by the OEM. These passwords are confidential and may be assigned to authorized personnel only
- The responsibility for setting parameters is assumed by the person who, in accordance with the access rights, has made changes on the respective setting level

In particular, the OEM assumes responsibility for the correct parameter settings in compliance with the standards covering the specific applications (e.g. EN 676, EN 267, EN 1643, etc.).

11 Actuators X53 / X54

One or 2 actuators can be connected to the LMV27, depending on the selected operating mode (refer to chapter *Selection of operating mode*).



Caution!

When mounting the actuators, it must be made certain that the mechanical link to the controlling elements is rigid!

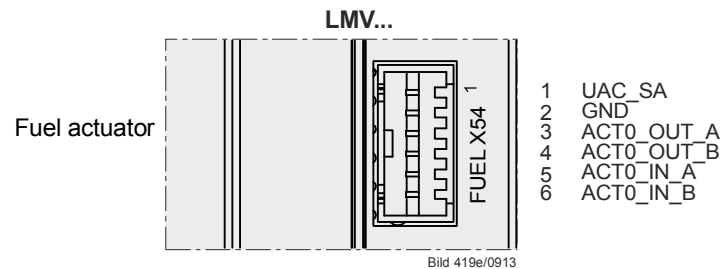

Figure 66: Fuel actuator (X54)

The actuators are suited for direct connection to the LMV27.

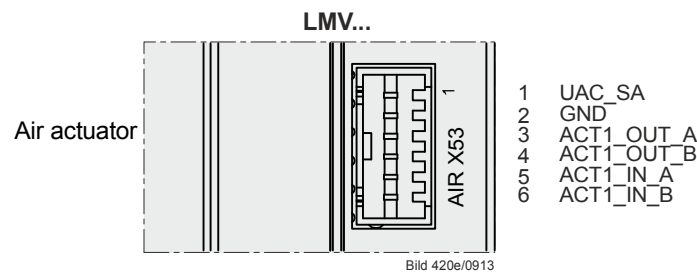

Figure 67: Air actuator (X53)

11.1 Function principle

The actuators are driven by stepper motors. The resolution reached when making 1 positioning step is 0.1°.

The running speed of the actuators is fixed at 5 seconds for a positioning angle of 90° for SQM33.4, SQM33.5, and SQN1.

The speed is 10 seconds for a positioning angle of 90° for SQM33.6.

The SQM33.7 requires 17 seconds for a positioning angle of 90°. An optical incremental transducer is used to monitor the current position. Due to the use of a gear train with almost no backlash, position control is not required.

11.2 Definition of angles

The angles and angular ranges are specified in the Data Sheets of the relevant actuators.

SQM33: Refer to Data Sheet N7813.

SQN1: Refer to Data Sheet N7803.

Also refer to figure *Angle definitions with SQM33*.

11.3 Referencing

An incremental transducer is used for position feedback. This means that referencing of the actuators must be performed after power-on. In addition, at the end of each shutdown in phase 10, the actuators are referenced to ensure that individual stepping errors, which could lead to shutdown, do not accumulate. If a position error occurs, the LMV27 switches to the safety phase (Ph01), enabling the actuators with detected position errors to be referenced. During the following phase 10, the only actuators referenced are those that were not referenced before in the safety phase (phase 01). The position of the reference point can be selected depending on the type of burner, either the CLOSE position ($<0^\circ$) or the OPEN position ($>90^\circ$).

When using actuators SQM33.6 or SQM33.7, the actuator type (parameter 613) must be set (refer to chapter *Actuator type / running time*).



Note!

If a SQM33.7 is used, the modulating operating ramp (parameter 544) may need to be increased (refer to chapter *Running speed / maximum curve slope*).

No.	Parameter
544	Ramp modulating
601	<p>Selection of reference point Index 0 = fuel Index 1 = air</p> <p>Setting values: 0 = closed (<0°) 1 = open (>90°)</p>
602	<p>Actuator's direction of rotation Index 0 = fuel Index 1 = air</p> <p>Setting values: 0 = counterclockwise 1 = clockwise (exclusively for SQM3)</p>
606	<p>Tolerance limit of position monitoring (0.1°) Index 0 = fuel Index 1 = air</p> <p>Greatest position error where an error is securely detected → error detection band: (parameter 606 -0.6°) up to parameter 606</p>
611	<p>Type of reference Index 0 = fuel Index 1 = air</p> <p>Setting values: 0 = standard 1 = range stop in the usable range 2 = internal range stop (SQN1) 3 = both</p>
613	<p>Type of actuator Index 0 = fuel Index 1 = air</p> <p>Setting values: 0 = 5 s / 90° (1 Nm, 1,2 Nm, 3 Nm) 1 = 10 s / 90° (6 Nm) 2 = 17 s / 90° (10 Nm)</p>



Application note!

Single-sided load torque is recommended due to the type of gear train for the SQM33.6 / SQM33.7 actuators. In the event of load on both sides, a backlash of $\pm 0.3^\circ$ must also be considered in addition to plant design or setting

11.3.1 Reference travel

Reference travel means that different reference travels are performed, aimed at unambiguously determining the actuators' permissible working range. This prevents the actuators from traveling to a range outside the optical feedback system or against a mechanical stop should a power failure during referencing occur. Parameter 611 must be set depending on the mechanical construction and the type of actuator used. In the case of reference travel type 1 the SQM33 actuator first travels to the starting point.



Note!

Always select reference travel type 2 for SQN13 and SQN14.

Parameterization for reference travel type 0 and type 2

No.	Parameter	Setting for actuator		
		SQM33	SQN13	SQN14
611	Type of referencing			
	Index 0 = Fuel	0	2	2
	Index 1 = Air	0	2	2

Parameterization for reference travel type 1

No.	Parameter	Setting for actuator type		
		SQM33		
611	Type of referencing			
	Index 0 = fuel	1		
	Index 1 = air	1		

To prevent the actuator from running against a mechanical stop during referencing, the home position may have to be adjusted (depending on the direction of rotation and a reference point of about 3° or 87°). In the case of stops within the usable range, the prepurge or postpurge position must be checked also.

Refer to the figure below for details of the reference travel.

Example of actuator with counterclockwise rotation:

When referencing in the CLOSE position, the actuator first travels a certain distance into the working range (towards the OPEN position). Then, it travels to a position representing maximum -7.7° , thereby crossing the reference mark for the first time. Then, the actuator moves in the other direction again and detects the inner ramp of the reference mark. This is the reference point used by all positions. If the reference point is parameterized in the OPEN position, referencing takes place in a mirror-symmetrical manner. In that case, the actuator first travels into the working range (toward the OPEN position). Then, it crosses the reference mark and travels to a position representing maximum 110.6° , then back to the inner ramp of the reference mark.

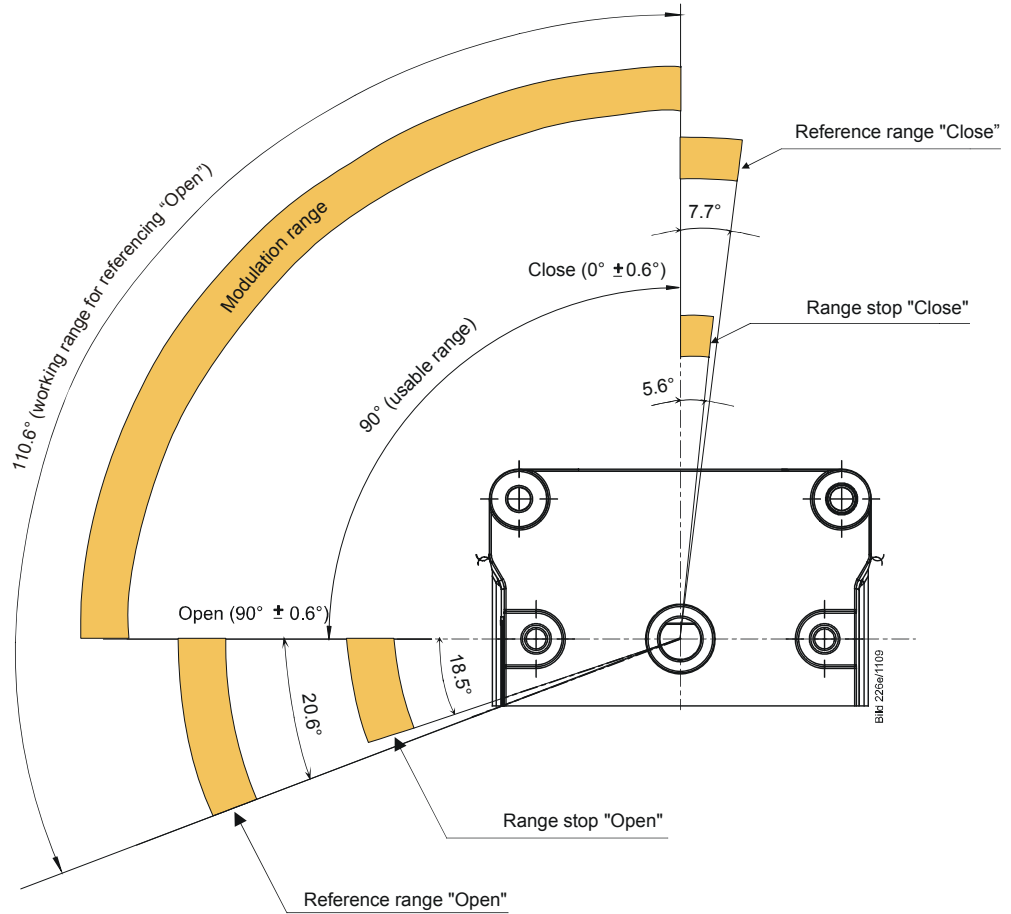

Figure 68: Angle definitions with SQM33

Error code	Diagnostic code	Meaning for the LMV27
85	0	Referencing error of fuel actuator
	1	Referencing error of air actuator
	Bit 7 Valency ≥ 128	Referencing error due to parameter change

11.4 Direction of rotation

With the SQM3 actuator, the direction of rotation can be selected on an individual basis.

No.	Parameter
602.00	Actuator's direction of rotation Index 0 = fuel Setting values: 0 = counterclockwise 1 = clockwise (exclusively for SQM3)
602.01	Actuator's direction of rotation Index 1 = air Setting values: 0 = counterclockwise 1 = clockwise (exclusively for SQM3)

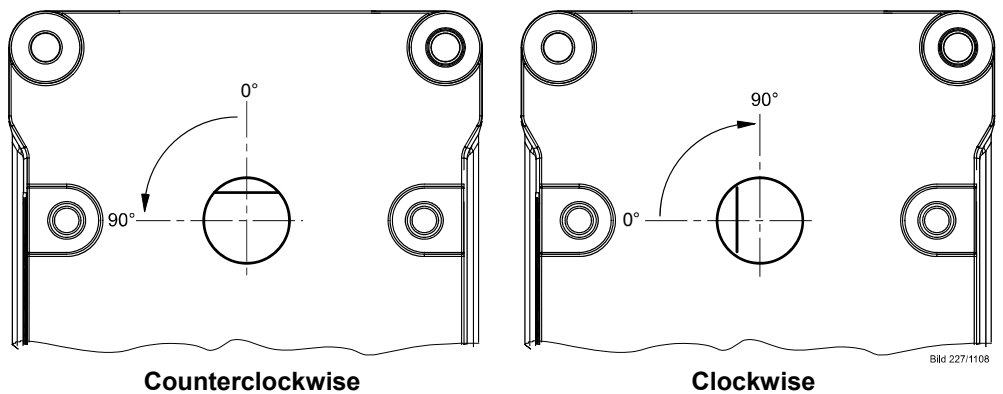

Figure 69: Direction of rotation (example SQM3)

The direction of rotation of the SQN1 actuators depends on the version:

- SQN13: Direction of rotation *Left*
- SQN14: Direction of rotation *Right*



Note

The actuators are always supplied with the flat of the drive shaft facing upward.

11.5 Monitoring the actuator positions

To monitor the actuator's current positions, an optical incremental transducer with a resolution of 0.7° is used. The correct position of the drive shaft is ensured by comparing the motor steps made with the position obtained from the incremental transducer. Due to the different resolutions of motor steps and incremental transducer plus the selected tolerance band, the following error detection band is obtained. The position where – in the error detection band – shutdown takes place depends on the position currently required.

For the default setting made in the factory, the error detection band is as follows:

Smallest position error where an error can be detected	1,1°
Greatest position error where an error is securely detected (default setting parameter 606)	1,7°

The presetting of 1.7° (default setting, parameter 606) is suited for use with actuators type SQN1 and SQM3.



Note

When using SQN1 actuators equipped with plastic gear trains, we recommend to change the preset values as follows:

Product no.	Value
SQN13.14	1.7°
SQN14.14	1.7°
SQN13.17	2.2°
SQN14.17	2.2°

When referencing under output conditions, the resilience of the actuator's gear train must also be taken into consideration:

Product no.	Resilience at max. rated driving torque
SQM33.41	0.2°
SQM33.51	0.2°
SQM33.6	0.2°
SQM33.7	0.2°
SQN13.14	0.3°
SQN13.17	0.8°
SQN14.14	0.3°
SQN14.17	0.8°

The error detection time is <1 second.



Caution!

This means that – for the design and setting of the burner – a position error resulting from the sum of ...

- greatest position error from which an error is detected in all positions,
- resilience at the max. rated torque, and
- mechanical influence from the link between actuator and regulating unit (e.g. coupling)

must not lead to a critical state in terms of safety.

No.	Parameter
606	Tolerance limit of position monitoring (0.1°) Index 0 = fuel Index 1 = air Greatest position error where an error is securely detected → error detection band: (parameter 606 -0.6°) up to parameter 606

Error code	Diagnostic code	Meaning for the LMV27
86	0	Position error fuel actuator
87	0	Position error air actuator

11.6 Changing the error detection band for monitoring the actuator positions

The error detection band can be changed via parameter 606. A change is to be made only when using SQN13.17 or SQN14.17 actuators which, due to their mechanical design, require greater tolerances.

For these types of actuators, set parameter 606 to 2.2°.

No.	Parameter
606	Tolerance limit of position monitoring (0.1°) Index 0 = fuel Index 1 = air Greatest position error where an error is securely detected → Error detection band: (parameter 606 -0.6°) up to parameter 606

11.7 Forced travel

There are errors in the actuators' feedback unit which can only be detected in connection with position changes. To be able to also detect such errors when maintaining the same position for longer periods of time, travel is enforced when – for more than 50 minutes – an actuator moves no more than 2.8°. With forced travel, both actuators are driven 2.8° in the direction of smaller positioning angles and back again to the initial angular position. If a damper is less than 2.8° open, the actuator is driven in the direction of positive angles in order not to run against mechanical stops, if present. Forced travel lasts a total of 1 second.

11.8 Detection of line interruptions

The connecting line ensuring position feedback from the actuator to the LMV27 is monitored for interruptions, which means that position feedback cannot fail without being noticed.

Error code	Diagnostic code	Meaning for the LMV27
86	Bit 0 Valency 1	Line interruption fuel actuator
87	Bit 0 Valency 1	Line interruption air actuator

11.9 Protection against actuator mixup

Mixup of actuators can be detected through appropriate mounting (using different reference marks for the air and fuel actuator: OPEN / CLOSE / 0° / 90°). With at least one of the actuators, the reference mark not used must be blocked by a mechanical stop. Now, if the actuator connections with the LMV27 have been interchanged, one of the actuators cannot reach the reference mark, which is detected by the LMV27. Protection against mixup is a question of burner application and must be ensured by the OEM.



Caution!

To be able to detect mixup of actuators, the burner manufacturers must ensure that the 2 actuators use opposing reference points. One of the actuators uses the OPEN reference, the other the CLOSE reference. Approach of the reference point not used must be blocked with at least one of the actuators!

11.9.1 Proposal for implementation

- Parameterize referencing of the air damper in the CLOSE position
- Parameterize referencing of the fuel damper in the OPEN position. Unnecessary travel can be avoided by defining a rest position of **90°** for the fuel damper
- Mechanical stop at the air damper in the range between 90° and 108.5°, and / or mechanical stop at the fuel damper in the range between 0° and -5.6°

Referencing process

- From any position in the working range (0...90°), but typically from the home position, the air damper travels to the **-7.7°** position and back again to the home position
- From any position in the working range (0...90°), but typically from the home position, the fuel damper travels to the **110.6°** position and back again to the home position

Process in the event of actuator mixup

- The fuel damper (fitted in place of the air damper) travels to the **-7.7°** position and back again to the home position
- The air damper (fitted in place of the gas damper) tries to travel to the **110.6°** position, but is prevented from doing so by the mechanical stop. This is unsuccessful travel and identified as actuator mixup

12 Load output X74 pin 3

This output delivers the current burner output. The analog output is a voltage output and – using parameter 645 – can be switched between DC 0...10 V, DC 2...10 V and DC 0/2...10 V.

Parameter 645	Voltage range	Remarks
0	DC 0...10 V	No detection of line interruption
1	DC 2...10 V	Detection of line interruption possible
2	DC 0/2...10 V	No detection of line interruption



Note

When changing the analog output configuration from DC 0...10 V to DC 2...10 V or DC 0/2...10 V, the voltage values with modulating, 2-stage and 3-stage operation change (refer to chapters *Modulating operation*, chapter *2-stage operation*, and chapter *3-stage operation*).

Conversion: New value = (initial value * 0.8) + 2

Example: Initially 2 V → (2 * 0.8) + 2 = 3.6 V

Initially 5 V → (5 * 0.8) + 2 = 6 V

No.	Parameter
645	Configuration of analog output 0 = DC 0...10 V 1 = DC 2...10 V 2 = DC 0/2...10 V

12.1 Safe separation of mains voltage and extra low-voltage



Caution!

The load output is designed for SELV or PELV (refer to chapter *Electrical connection of the LMV27*). For this reason, strict separation from the mains voltage side must be ensured!

This necessitates power supply by an external power pack (X74 pin 1, X74 pin 2).

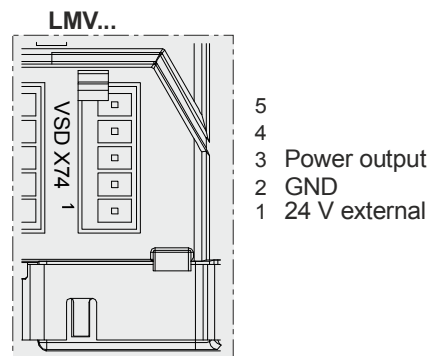

Figure 70: Power output

12.2 Modulating operation

Actual value	Voltage	Curvepoint	Display / output value
Off	DC 0 V	---	Off
Ignition load	DC 1 V	P0	10%
Low-fire	DC 2 V	P1	20%
High-fire	DC 10 V	P9	100%

The values between low-fire and high-fire are interpolated in a linear manner.

12.3 2-stage operation

Actual value	Voltage	Curvepoint	Display / output value
Off	DC 0 V	---	Off
Stage 1	DC 5 V	P1	P1
Stage 2	DC 10 V	P2	P2

12.4 3-stage operation

Actual value	Voltage	Curvepoint	Display / output value
Off	DC 0 V	---	Off
Stage 1	DC 3 V	P1	P1
Stage 2	DC 5 V	P2	P2
Stage 3	DC 10 V	P3	P3

13 Fuel meter input X75 pin 1 / X75 pin 2

A fuel meter can be connected to acquire the amount of fuel burnt.



Figure 71: Fuel meter input X75

13.1 Configuration of fuel meter

13.1.1 Types of fuel meters

The LMV27 is designed for use with fuel meters equipped with a Reed contact. Pulse frequency at maximum fuel throughput must be below 300 Hz.

13.1.2 Configuration of pulses per volume unit

Depending on the type of fuel meter used, the number of pulses supplied by it per m^3 or l fuel must be parameterized. A maximum of 400 pulses per volume unit can be preset. The correct amount of fuel is acquired only when this parameter is set.

When the parameter is **0**, the fuel meter stops.

No.	Parameter
128	Fuel meter: Pulse valency (pulses / volume unit)

13.1.3 Reading and resetting the meter readings

No.	Parameter
167	Fuel volume resettable (m^3 , l, ft^3 , gal)

The cumulated fuel volume can be read out per parameter. The reading can also be reset on the parameter level.

13.2 Fuel throughput

With the fuel meter connected, the LMV27 calculates continuously the current fuel throughput. The time required for calculating the fuel throughput varies and lies between 1 and 10 seconds. If the fuel meter delivers no pulses for more than 10 seconds, the display shows **0** fuel throughput. This means that when fuel throughput is at its minimum, the sensor should have a pulse frequency of at least 0.1 Hz. The display is smoothed to improve the settling process. With fuel throughput at its maximum, the maximum frequency is 300 Hz.

13.2.1 Configuration

Calculation of fuel throughput is configured based on the pulse valency of the connected fuel meter.

No.	Parameter
128	Fuel meter: Pulse valency (pulses/volume unit)

When the pulse valency is set to 0.00, the display shows **0** throughput.

13.2.2 Reading out the fuel throughput

The current fuel throughput can be read out via the following parameter on the service menu:

No.	Parameter
960	Fuel throughput in volume unit /h (m ³ /h, l/h, ft ³ /h, gal/h)

Display of fuel throughput is possible up to 6553 volume units/h.



Note

Display of fuel throughput up to a value of **99.9** on the service menu is made with one decimal place, from **100** with no decimal place.

14 Connection and internal diagram

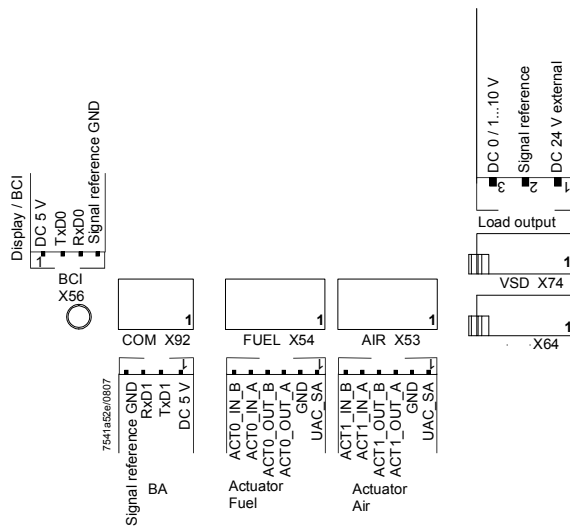
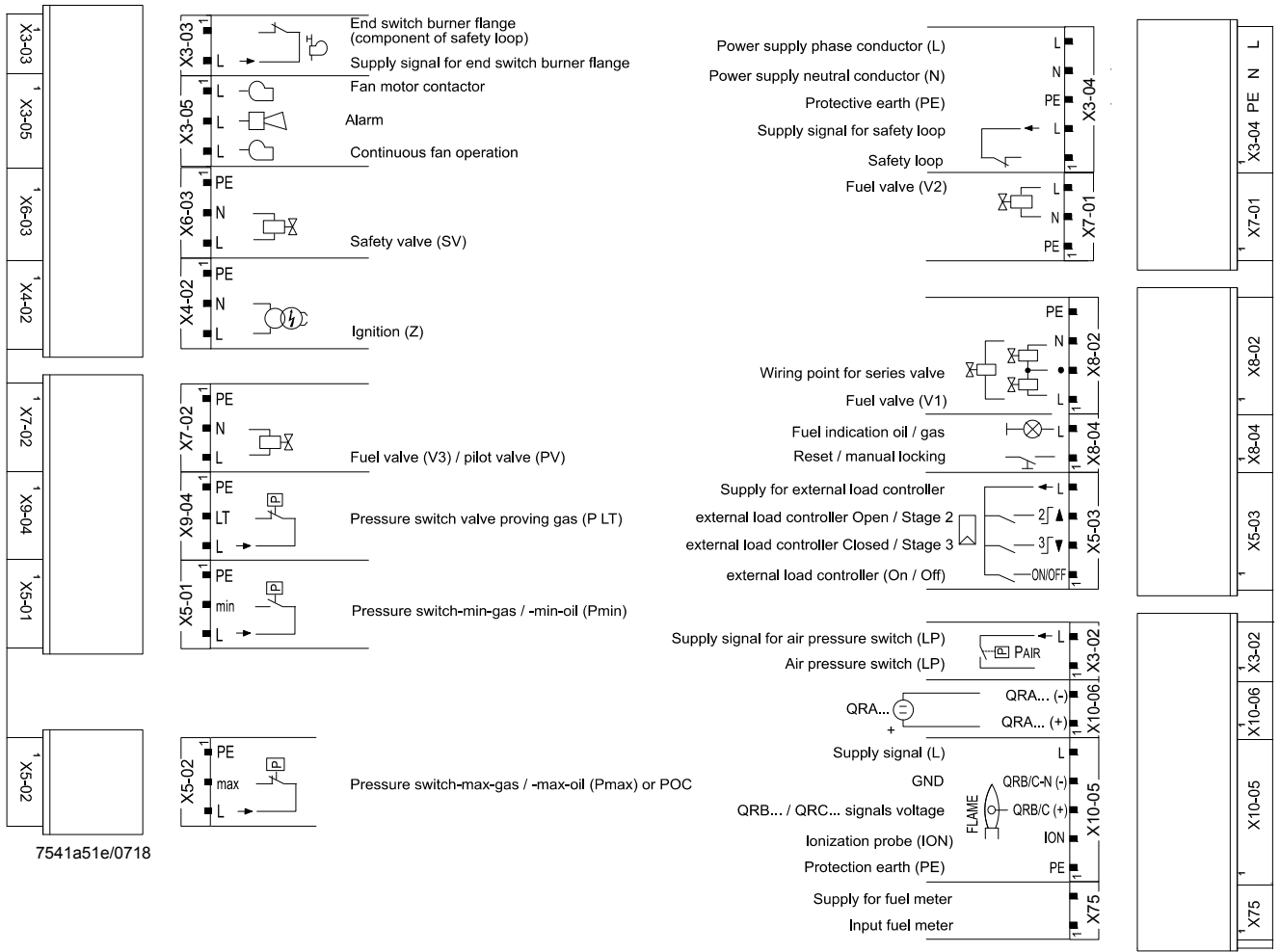

Figure 72: Inputs and outputs

15 Special feature: Burner identification

The OEM must assign an individual burner identification to every burner. This ensures that during backup/restore, incompatible parameter sets cannot be copied between different burners (also refer to the documentation on the ACS410 PC software under *Backup/Restore* and in this documentation in chapter *Backup / Restore*).

No.	Parameter
113	Burner identification

16 Connection to superposed systems

16.1 General information and building automation functions

Communication with building automation is made possible via a data link using the COM X92 port and a special interface with galvanic separation and physical bus level adaptation.

This port can be used for connection of a LMV27 with Modbus, depending on the configuration made.

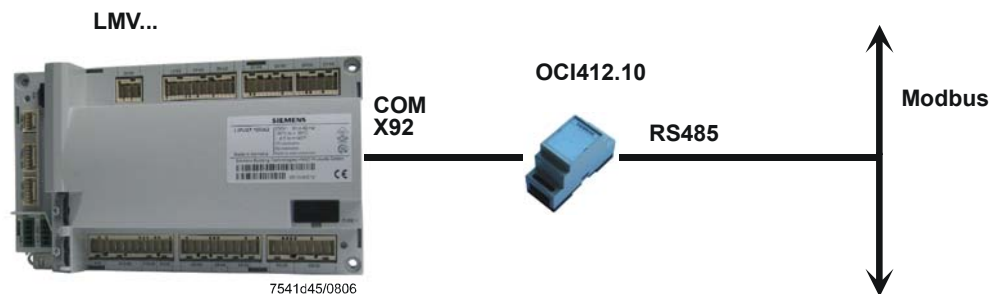

Figure 73: Connection via interface COM 92 to superposed systems



Note

Breakdown of bus communication.

If the LMV27 detects a breakdown of bus communication, the BAC system must rewrite the following values upon restoration of communication:

- Modbus: Mode, Modbus operating mode, and predefined target output

General setting values for connection of the LMV27 to building automation (for factory settings, refer to the *Parameter list*):

Bus communication may only be interrupted for the time set.

If communication is disturbed for a longer period of time, the LMV27 delivers a fault status message and the values set in the LMV27 by building automation are reset.

No.	Parameter
141	Operating mode building automation 0 = off 1 = Modbus 2 = reserved
142	Setback time in the event of communication breakdown Setting values 0 = inactive 1...7200 s
148	Predefined output in the event of communication breakdown with building automation Setting values: For modulating operation , the setting range is as follows: 0...19.9 = burner off 20...100 = 20...100% burner output (20 = low-fire position) For multistage operation , use the following settings: 0 = burner OFF P1...P3 = stage 1...stage 3 Invalid = no output predefined by the building automation system in the event of communication breakdown Default setting: <i>Invalid</i>

The factory settings of the parameters are shown on the *Parameter list*.



Note

For a detailed description of parameter 148, refer to chapter *Default output via building automation*.

16.2 Modbus

With this type of bus protocol, the LMV27 operates as a slave on the Modbus and the transmission mode used is RTU (Remote Terminal Unit).

For more detailed information, refer to the Modbus User Documentation (A7541).

No.	Parameter
145	Device address for Modbus of LMV27 Setting values 1...247
146	Baud rate for Modbus 0 = 9600 1 = 19200
147	Setting of parity for Modbus communication 0 = none 1 = odd 2 = even

The factory settings of the parameters are shown on the parameter list.



Note

If bus communication breaks down, the mode, Modbus operating mode and predefined target output must be rewritten.

17 PC software ACS410

The ACS410 PC software serves primarily as an operating module for the LMV27, providing the following basic functions:

- Visualization of system state via the following data:
 - Parameters
 - Process data
- Configuration and parameterization of the LMV27 (individual parameters)
- Backup and recovery of parameter sets



Note

For notes on operation and commissioning, refer to chapter *Operation*.

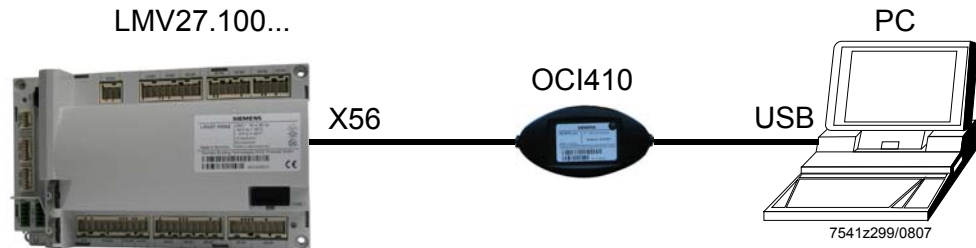

Figure 74: Communication with display / BCI (RJ jack) (X56)

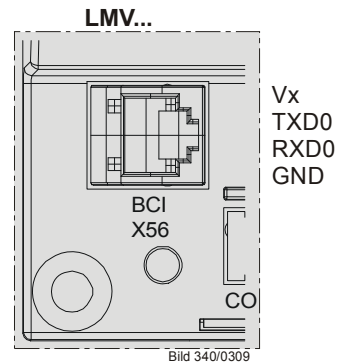

Figure 75: Display input BCI (RJ11 jack) X56

If communication between the LMV27 and the ACS410 (70 s) has broken down, the password level is reset to *Info / Service*.



Caution!

Interruption of communication between the LMV27 and the ACS410 (30 seconds) during the time the curves are set leads to lockout!

Error code	Diagnostic code	Meaning for the LMV27
167	9	Manual locking via ACS410 PC software communication interruption

18 Error history

The LMV27 provides an error history in which the last 25 errors are stored. The first entry represents the current error state and can also be *error-free* (see chapter to error code list).

Error code	Diagnostic code	Meaning for the LMV27
200 OFF	#	LMV27 error-free

18.1 Error classes

The errors are subdivided into error classes, depending on the severity of the switch-off response. The current error shows all classes. Only the errors of the most important classes are included in the history.

Error class	Priority	Meaning	History
0	Highest	Lockout	●
1		Safety shutdown with software reset	●
2		Undervoltage	
3		Safety shutdown: Safety phase	●
4		Safety shutdown: Start prevention	
5		Safety shutdown: Shutdown	●
6	Lowest	Message without shutdown response	

18.2 Makeup of error history

Parameter	Index	Description
701		Current error state, can also be error-free
	.01	Error code (200 = error-free) → refer to chapter <i>Error code list</i>
	.02	Diagnostic code → refer to chapter <i>Error code list</i>
	.03	Error class → error classes
	.04	Error phase: Phase in which error occurred → sequence diagrams
	.05	Startup counter. Startup meter reading (parameter 166) at which the error occurred
	.06	Power: Burner output at which the error occurred
702	.01..06	Latest error in the history
•		
•		
•		
725	.01..06	Oldest error in the history

No.	Parameter
166	Total number of startups

Deleting the error history

Both the service menu and the parameter setting menu show the error history. The display on the service menu can be deleted in a way that the only errors shown are those that occurred after the deletion. The error history on the parameter setting menu cannot be deleted.

For the deletion, parameter 130 must be set to **1** and then to **2** within 6 seconds. When the parameter returns to **0**, the deletion process is completed.

No.	Parameter
130	Delete display of error history To delete the display: Set the parameter to 1, then to 2. Response 0: Job successfully Response: -1: Timeout of 1_2-Sequence

19 Lifecycle function

If the startup counter exceeds a defined threshold, a display error code is set and displayed. The error can be acknowledged.

The display code is always set in *Standby* mode (when there is no heat request). Hence, the moment the threshold is exceeded, the user is notified that the end of the lifecycle of the LMV27 will soon be reached.

Error code	Diagnostic code	Meaning for the LMV27
116	0	Designed lifecycle exceeded (250,000 startups)



Note

The LMV27 should be replaced when this message appears.

20 Safety notes on use of the AZL2

Caution!

To prevent the risk of fire and explosions, damage to heating plant or damage resulting from improper use of the products, ensure that the following safety notes are observed:

The burner management system covered by the present Basic Documentation may only be used as specified and only in connection with the appropriate burner and heating plant.

The burner management system with its AZL2 and the associated heating control system may only be installed and commissioned by authorized technical personnel.



The AZL2 may only be used in dry spaces. Do not use AZL2 outdoors and protect it against excessive temperatures and frost, and liquids, such as water, oil, fuel oil, etc.

Follow exactly the procedures and setting notes given in this Basic Documentation. Appropriately identified settings must only be made by authorized technical personnel.

If the AZL2 is dusty or dirty, clean it with a dry cloth.

Do not carry out any maintenance or repair work on the AZL2. Such work may only be performed by authorized technical personnel.

If you have any questions in connection with the AZL2, please contact your heating engineer or refer to one of the addresses given in this Basic Documentation.

21 Operating via AZL2 unit

21.1 Description of unit / display and buttons

Function and operation of unit versions AZL21 and AZL23 are identical.

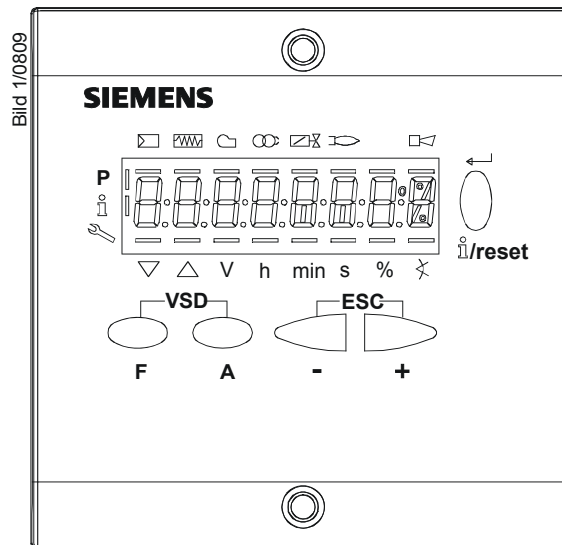







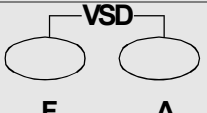





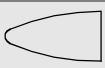
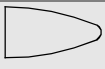
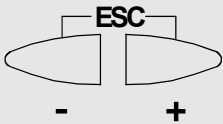



Figure 76: Description of unit / display and buttons

Button	Function
 F	Button F - For adjusting the fuel actuator (keep  depressed and adjust the value by pressing  or )
 A	Button A - For adjusting the air actuator (keep  depressed and adjust the value pressing  or )
 F A	Buttons A and F: Parameter function - For changing to parameter setting mode P (press simultaneously  and  plus  or )
 i/reset	Info and Enter button - For navigating in info or service mode * Selection (symbol flashing) (press button for <1 s) * For changing to a lower menu level (press button for 1...3 s) * For changing to a higher menu level (press button for 3...8 s) * For changing the operating mode (press button for >8 s) - Enter in parameter setting mode - Reset in the event of fault - One menu level down
 -	- button - For decreasing the value - For navigating during curve adjustments in info or service mode
 +	+ button - For increasing the value - For navigating during curve adjustments in info or service mode
 - +	+ and - button: Escape function (press  and  simultaneously) - No adoption of value - One menu level up

21.2 Meaning of symbols on the display

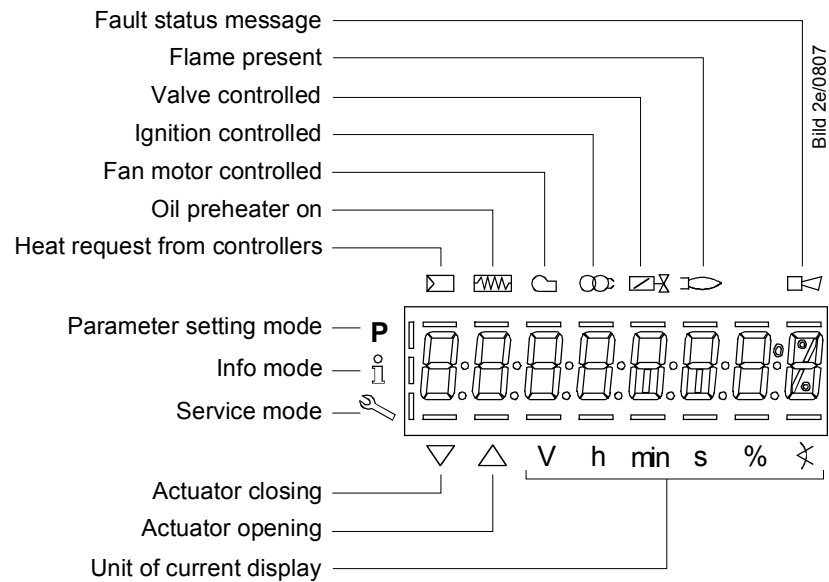

Figure 77: Meaning of display

21.3 Brightness of display

Only available with backlit LCD:

The function of the backlit display is dependent on the type of LMV27.

The brightness of the display can be adjusted from 0...100% using parameter 126.

No.	Parameter
126	Brightness of display

21.4 Special functions

21.4.1 Manual lockout



/reset
plus other button

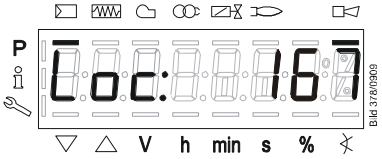

Press  **/reset** **simultaneously** with any other button.

The LMV27 switches instantly to the lockout position, irrespective of the operating position.

The display shows the fault status message.

(Refer to chapter *Error code list!*)

Display: **Loc: 167**

The reset must be carried out as follows:





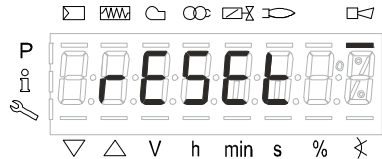

/reset
1 s

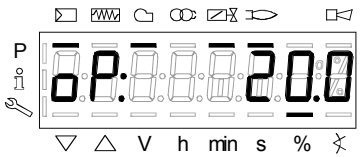

When  **/reset** is pressed for 1 second, **rESEt** appears on the display.

When the button is released, the LMV27 is reset.

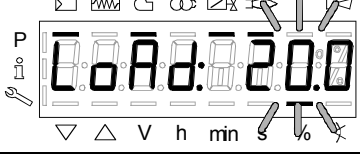
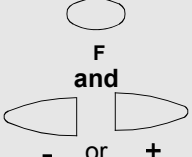
21.4.2 Manual control (manual request for output)

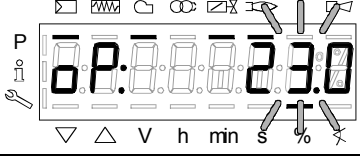
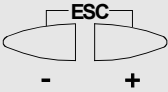
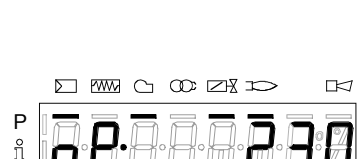
		<p>Burner is in operation.</p> <p>The display shows oP: on the left, the percentage of the current output on the right.</p> <p>Example: oP: 20.0</p>
 <p>F 1 s</p>		<p>Press F for 1 s.</p> <p>The display shows LoAd:, the current output flashes.</p>
 <p>F and - or +</p>		<p>Press - or + to adjust the required manual output.</p> <p>Example: oP: 23.0</p>
		<p>Release F.</p> <p>The current manual output flashes, indicating that manual control is activated.</p>
 <p>ESC - +</p>		<p>Press - + for 3 s to return to automatic mode.</p> <p>The output no longer flashes.</p> <p>The display shows oP: on the left, the percentage value on the right.</p> <p>Example: oP: 23.0</p>

21.5 Timeout for menu operation

The time for automatically leaving the parameter setting level can be adjusted between 10 and 120 minutes, using the following parameter.

No.	Parameter
127	Timeout for menu operation

If, during that period of time, there is no operation via the AZL2, the parameter setting level is quit and the password level reset to *Info / Service*.



Caution!

In addition, this timeout or interruption of communication between LMV27 and AZL2 during the time the curves are set, leads to lockout!

Error code	Diagnostic code	Meaning for the LMV27
167	8	Manual locking via AZL2 Timeout / communication interruption

21.6 Backup / restore

Using the AZL2, the settings made on the LMV27 can be stored (backup) and then transferred back to the LMV27 at a later point in time.

Creating a backup data set

No.	Parameter
050.0	Index 0: Creation of backup

The following parameters can be used to read information about the backup data set:



No.	Parameter
055	Burner identification of the AZL2 backup data set
056	ASN extraction of the AZL2 backup data set
057	Software version used when creating the AZL2 backup data set

Restoring a backup data set

To transfer a backup data set back to the LMV27, the parameter must be set to **1**.

No.	Parameter
050.1	Index 1: Execute restore

21.6.1 Backup

		<p>Parameter 000: flashes.</p> <p>Display: Parameter 000: flashes, Int does not.</p>
		<p>Press + to select parameter 050</p> <p>Display: Parameter 050. flashes, index 00: and value 0 do not.</p>
		<p>Press  to select parameter bAC_UP</p> <p>Display: Parameter bAC_UP</p>
		<p>Press  to select the backup process.</p> <p>Display: Value 0</p>
		<p>Press + to shift the value in change mode 1 position to the left.</p> <p>Display: Value 1 flashes</p> <p>Note To detect potential display errors, the value is displayed 1 place shifted to the left.</p>
		<p>Press  to activate the backup process.</p> <p>Display: 1 appears</p>

Approx. 5 s

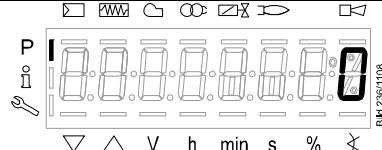

After about 5 seconds (depending on the duration of the program), **0** appears on the display, indicating the end of the backup process.

Display: **0**



Note

If an error occurs during the backup process, a negative value is displayed. For error diagnostics, the cause of the error can be determined from the diagnostic code of error message 137 (see *Error code list*).





Caution!

We recommend to make a backup whenever a parameter is changed!

21.6.2 Restore

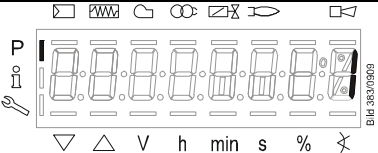
		<p>Parameter 000: flashes.</p> <p>Display: Parameter 000: flashes, Int does not.</p>
		<p>Press + to select parameter 050</p> <p>Display: Parameter 050. flashes, index 00: and value 0 do not.</p>
		<p>Press to go to parameter bAC_UP.</p> <p>Display: Parameter bAC_UP</p>
		<p>Press to go to the rEStorE function.</p> <p>Display: Parameter rEStorE</p>
		<p>Press to select the restore process.</p> <p>Display: Value 0</p>
		<p>Press to shift the value in change mode 1 position to the left.</p> <p>Display: Value 1 flashes.</p>
	<p>Note To detect potential display errors, the value is displayed 1 place shifted to the left.</p>	

 reset		<p>Press  to activate the restore process.</p> <p>Display: 1 appears</p>
---	---	--

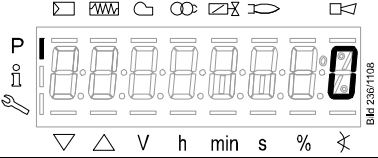
Ca. 8 s		<p>After about 8 seconds (depending on the duration of the program), 0 appears on the display, indicating the end of the backup process.</p> <p>Display: 0</p>
--------------------	---	--



Note

- Before restoring the backup data on the LMV27, the latter compares the burner identification and product no. (ASN) with the burner identification and product no. (ASN) of the backup data set. If the data accord, they are restored. If not, the restore process is aborted. In case of abortion, or if an error occurs during the restore process, the display shows a negative value. For error diagnostics, the cause of the error can be determined from the diagnostic code of error message 137 (see *Error code list*). When the restore process is successfully completed, value **0** appears on the display. The LMV27 is supplied with undefined burner identification. In that case, the restore process from the AZL2 is possible without having to enter the burner identification in the LMV27
- Information **Err C: 136 D: 1** (restore started) is displayed for a short moment



Caution!

On completion of the restore process, the sequence of functions and the parameter settings must be checked.

22 Operation of LMV27 via the AZL2

22.1 Normal display

Normal display is the standard display in normal operation, representing the highest menu level. From the normal display, you can change to the info, service or parameter level.

22.1.1 Display in standby mode

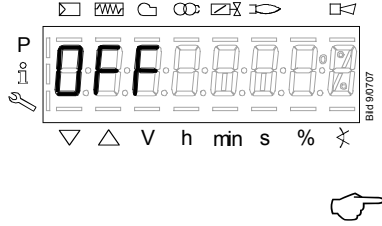



LMV27 is in standby mode.

Note!
OFF flashes when the *Manual OFF* function, the manual output, or load controller OFF is activated.

22.1.2 Display during startup / shutdown

22.1.2.1. Display of program phases



The LMV27 is in **Phase 22**. The load controller calls for heat. The bar below the  symbol appears. The individual program phases and controlled components are displayed in accordance with the program sequence.

22.1.2.2. Display of program phase with remaining running time until end of the phase is reached



The LMV27 is in **Phase 30** and shows the remaining running time in that phase.

Example: **12 s, Phase 30**

22.1.2.3. List of phase displays

Phase	Function
Ph00	Lockout phase
Ph01	Safety phase
Ph10	Home run
Ph12	Standby (stationary)
Ph22	Fan ramp up time (fan motor = ON, safety valve = ON)
Ph24	Traveling to the prepurge position
Ph30	Prepurge time
Ph35	Run the fan to ignition speed
Ph36	Traveling to the ignition position
Ph38	Preignition time
Ph39	Valve proving filling time (test pressure-switch-min when mounted between fuel valve V1 and fuel valve V2)
Ph40	1st safety time (ignition transformer ON)
Ph42	1st safety time (ignition transformer OFF)
Ph44	Interval 1
Ph50	2nd safety time
Ph52	Interval 2
Ph60	Operation 1 (stationary)
Ph62	Maximum time low-fire (operation 2, preparing for shutdown, traveling to low-fire)
Ph70	Afterburn time
Ph71	Run the fan to postpurge speed
Ph72	Traveling to the postpurge position
Ph74	Postpurge time (no extraneous light test)
Ph78	Postpurge time (abortion when load controller ON)
Ph79	Run the fan to standby speed
Ph80	Valve proving - test space evacuating
Ph81	Valve proving - test time atmospheric pressure
Ph82	Valve proving - test space filling
Ph83	Valve proving - test time gas pressure
Ph90	Gas shortage waiting time

22.1.3 Display of operating position

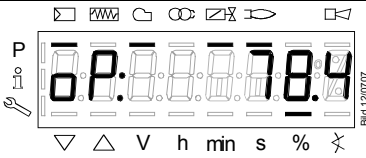
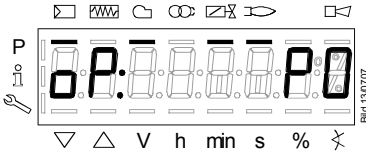
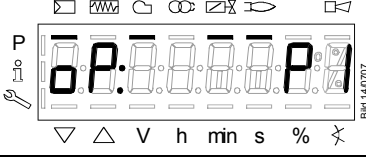
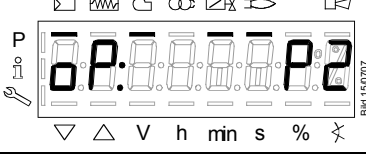
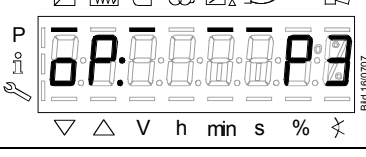
		<p>Display oP stands for <i>Operating position reached</i>. Modulating mode: Current output in %</p>
		<p>Display oP: P0 stands for <i>Ignition point</i>. Multistage mode: Current heating stage</p>
		<p>Display oP: P1 stands for <i>Stage 1</i>. Multistage mode: Current heating stage</p>
		<p>Display oP: P2 stands for <i>Stage 2</i>. Multistage mode: Current heating stage</p>
		<p>Display oP: P3 stands for <i>Stage 3</i>. Multistage mode: Current heating stage</p>

22.1.4 Fault status message, display of errors and info

22.1.4.1. Display of errors (faults) with lockout

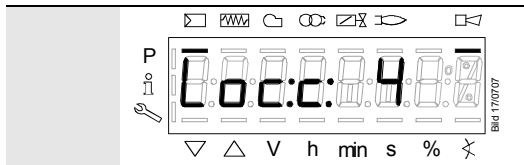

The display shows **Loc:**, the bar under the fault status message  appears.

The LMV27 is in the lockout position.

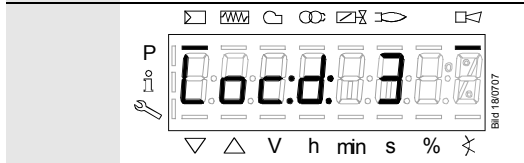

The display shows current error code **c:** alternating with diagnostic code **d:** (refer to *Flash code list*).

Example: Error code **4**/diagnostic code **3**

22.1.4.2. Reset

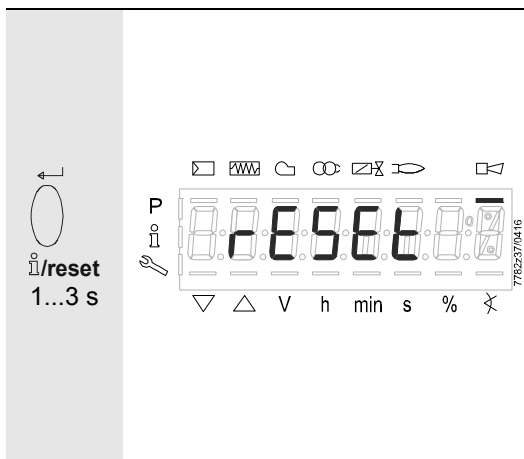

When pressing  for 1...3 s, **rESEt** appears on the display.

When the button is released, the LMV27 is reseted.

If the  button is pressed for a time other than the time indicated above, a change to the previous menu is made.

Exception

If an error occurred while setting the curve, a change back to the parameter setting level is made.

22.1.4.3. Activating info / service mode from lockout

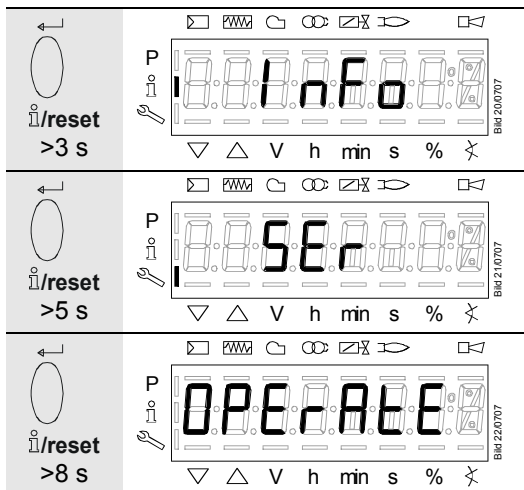

When pressing  for >3 s, the display shows **InFo**, **SEr** and then **OPERAtE**.

When the button is released, a change to info / service mode will be made.

22.1.4.4. Error with safety shutdown

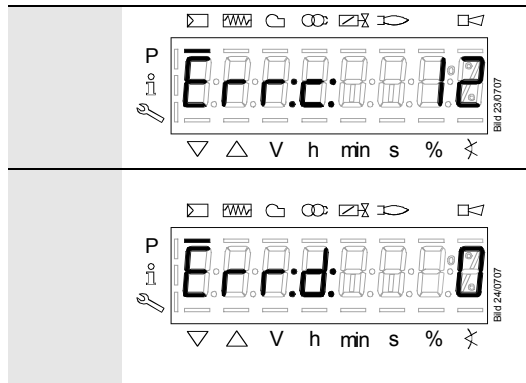

The display shows **Err:**.

The LMV27 initiates safety shutdown.

The display shows current error code **c**: alternating with diagnostic code **d**:

Press  to return to the normal display.

Example: Error code **12** / diagnostic code **0**

22.1.4.5. General information

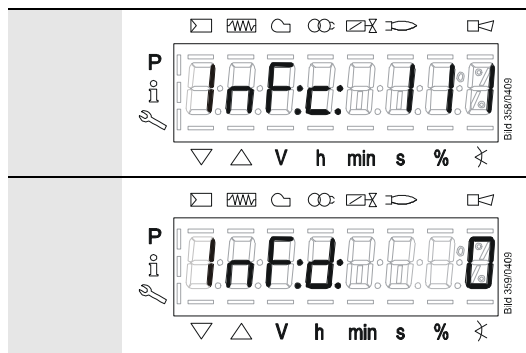

The LMV27 displays an event which does not lead to shutdown.

The display shows current error code **c**: alternating with diagnostic code **d**:

Press  to return to the display of phases.

Example: Error code **111** / diagnostic code **0**



Note

For meaning of the error and diagnostic codes, refer to chapter *Error code list*.
When an error has been acknowledged, it can still be read out from the error history.

22.1.4.6. Start prevention

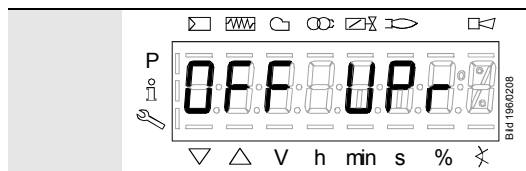

A non-programmed or not completely parameterized LMV27, or a LMV27 whose operating mode was reset or changed, displays **OFF UPPr**.

22.1.4.7. Safety loop



A LMV27 whose safety loop and / or the burner flange contact is open, and a load controller ON signal is present, displays **OFF S**.

23 Menu-driven operation

23.1 Assignment of levels

The various levels can be accessed via different button combinations. The parameter level can only be accessed via password.

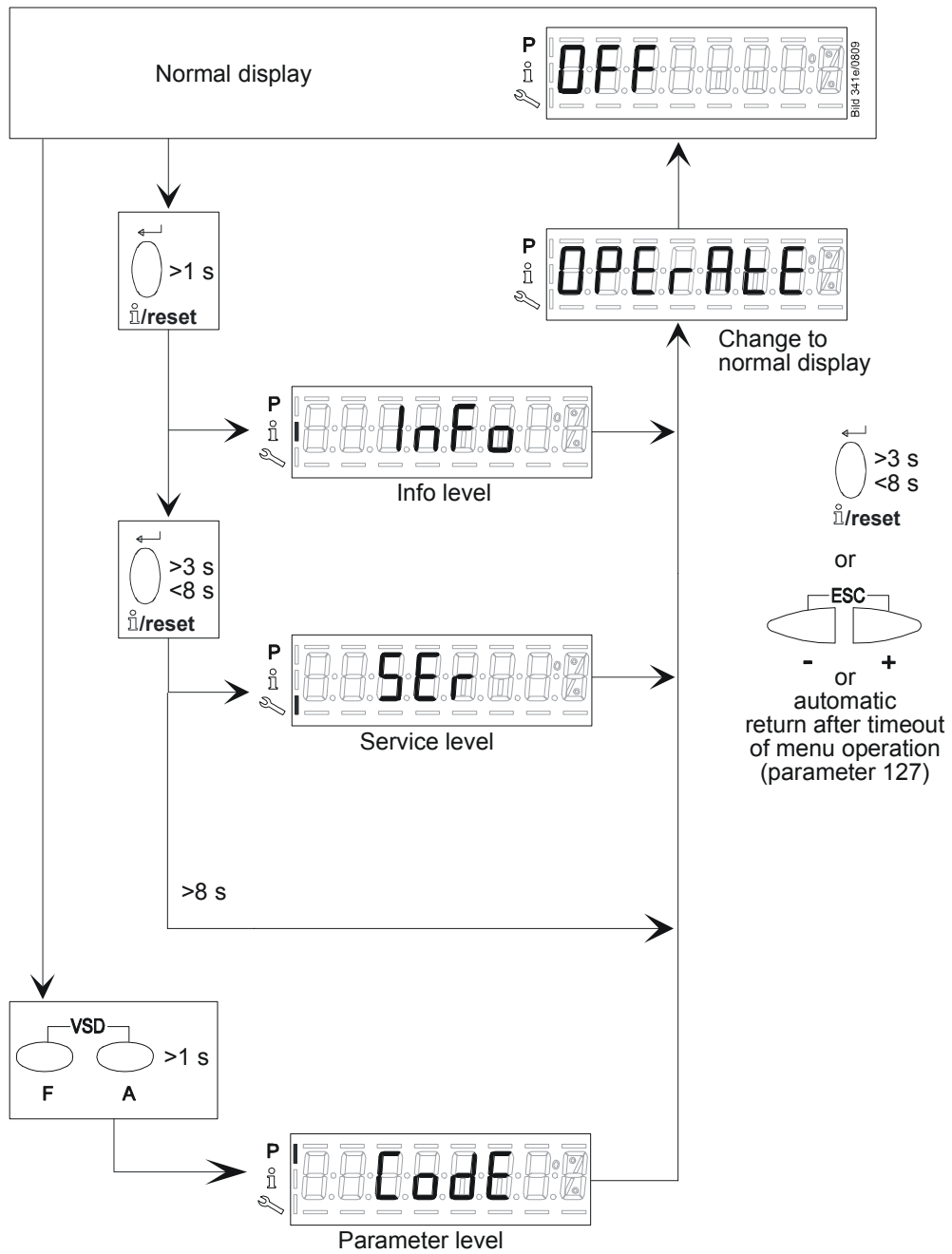
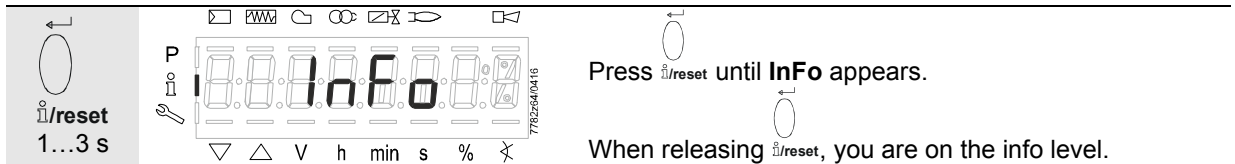

Figure 78: Assignment of levels

24 Info level

24.1 Display of info level



The info level displays information about the LMV27 and about operation in general.



Note

On the info level, you can press or to display the next or the previous parameter.

Instead of pressing , you can also press for <1 second.



Note

Press or for >8 seconds to return to the normal display.

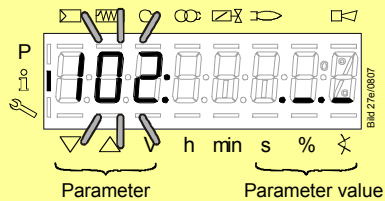

Figure 79: Info level

Note!

No change of values on the info level!

If the display shows below the parameter value, the value may consist of more than 5 digits.

The value is displayed by pressing for >1 s and <3 s.

Press for >3 s or press to return to the selection of the parameter number (parameter no. flashes).

No.	Parameter
Info level	
167	Fuel volume resettable (m ³ , l, ft ³ , gal)
162	Operating hours resettable
164	Startups resettable
163	LMV27 operating hours with power applied
166	Total number of startups
113	Burner identification
107	Software version
108	Software variant
102	Identification date
103	Identification number
104	Parameter set preassignment: Customer code
105	Parameter set preassignment: Version
143	Reserved
End	

24.2 Display of info values (examples)

24.2.1 Identification date

The identification date described below corresponds to the creation date for the program sequence and cannot be changed by the user.

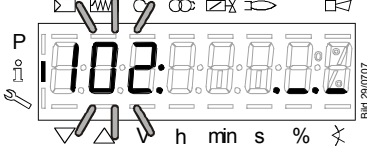

The display shows parameter **102**: flashing on the left, characters **._.** on the right.

Example: **102: ._.**

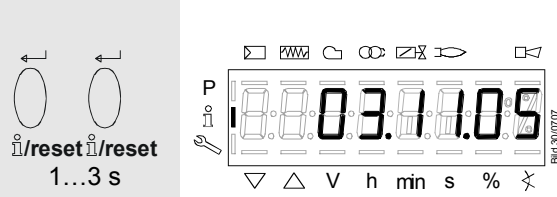

Pressing the button **i/reset** (1...3 seconds) and releasing it when **._.** flashes displays the identification date (creation date of the program sequence) **DD.MM.YY**.

Example: Identification date **03.11.05**

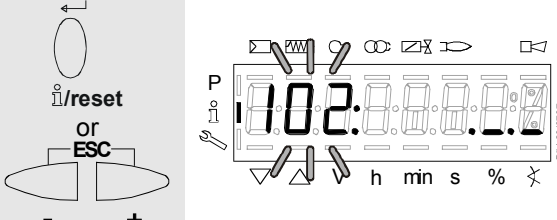

Press the **i/reset** or **ESC** button to return to the display of parameters.

To the next parameter



24.2.2 Identification number

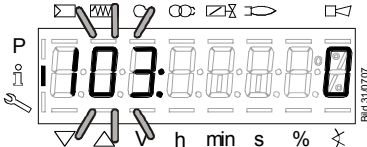

The display shows parameter **103**: flashing on the left, identification number **0** on the right.

Example: **103: 0**

To the next parameter

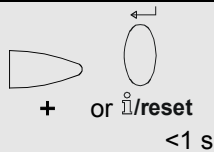

Back to the previous parameter.

24.2.3 Burner identification

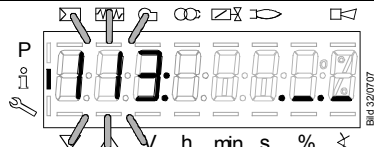

The display shows parameter **113**: flashing on the left, characters **. _ .** on the right.

Example: **113**: **. _ .**

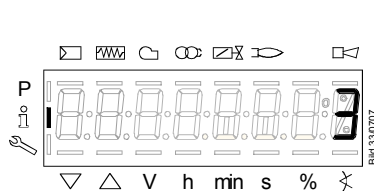

Press  for 1...3 s to show the burner's identification.

Default setting: -----

Example: **3**

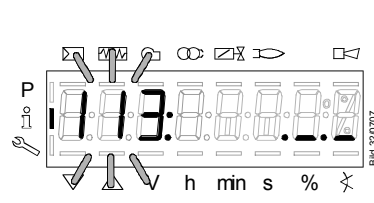

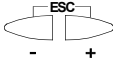
Press  or  to return to the display of parameters.

The burner's identification can be set on the parameter level!

To the next parameter  

 Back to the previous parameter.

24.2.4 Number of startups resettable



Note!

Can be deleted for service refer to chapter *Parameter list*

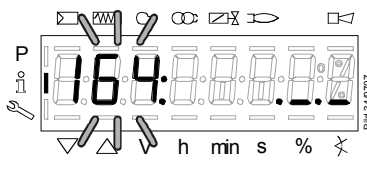

The display shows parameter **164**: flashing on the left, characters **._.** on the right, since display of the number of startups may comprise more than 5 digits.

Example: Parameter **164**: **._.**



/reset
1...3 s

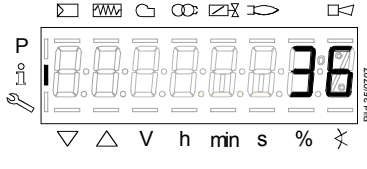

Pressing the button **/reset** (1...3 seconds) and releasing it when **._.** flashes displays the number of startups (can be reset).

Example: **36**



/reset
or
ESC

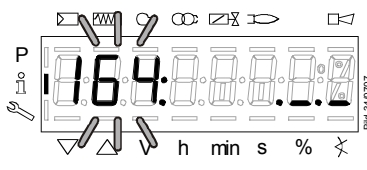

Press **/reset** or **- +** to show parameter **164** flashing again.

The number of startups can be reset on the parameter level!

To the next parameter   Back to the previous parameter.

24.2.5 Total number of startups

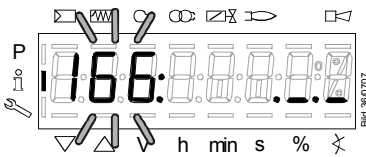

The display shows parameter **166**: flashing on the left, characters **. _ . _** on the right, since the display of the total number of startups may comprise more than 5 digits.

Example: Parameter **166**: **. _ . _**

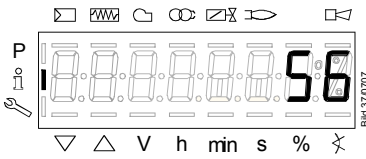

Pressing the button  (1...3 seconds) and releasing it when **. _ . _** flashes displays the total number of startups.

Example: **56**

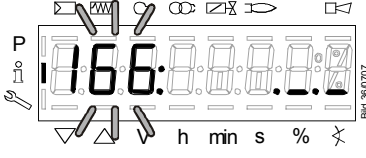

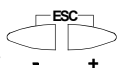
Press  or  to return to the display of parameters.

To the next parameter  +

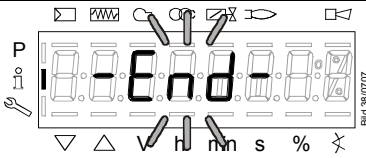

 - Back to the previous parameter.

24.2.6 End of info level





When this display appears, you have reached the end of the info level.

The display shows **- End -** flashing.

To the start of the info level  + or  **<1 s**

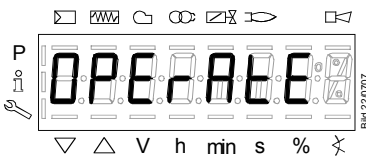
 - To end of info level



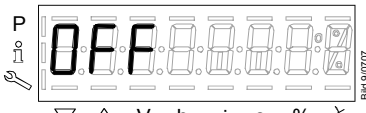

Press  or  (**>8 seconds**) to return to the operating mode display

OPERAtE appears for a short moment.



When this display appears, you are back on the normal display and you can change to the next level mode.

 **i/reset**

Press  to switch between the service and the parameter level.

25 Service level

The service level is used to display information about errors including the error history and information about the LMV27.



Note

When on the service level, you can press or to display the next or the previous parameter.

Instead of pressing , you can also press for <1 s.



Note

Press or for >3 s to return to the normal display.

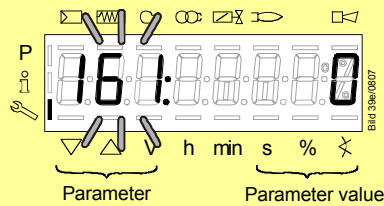

Figure 80: Service level

Note!

No change of values on the service level.

If characters `._.` are displayed by the parameter, the value may consist of more than 5 digits.

Press for >1 s and <3 s to display the value.

Press for >3 s or to return to the selection of the parameter number (parameter number flashes).

25.1 Display of service level

Press for >3 s until **SEr** appears.

When releasing , you are on the service level.



No.	Parameter
Service level	
954	Flame intensity
960	Actual flow rate (fuel throughput in m ³ /h, l/h, ft ³ /h, gal/h)
121	Manual output Undefined = automatic operation
922	Step position of actuators Index: 0 = fuel Index: 1 = air
161	Number of faults
701	Error history: 701-725.01.Code • Error history: 701-725.02.Diagnostic code • Error history: 701-725.03.Error class • Error history: 701-725.04.Phase • Error history: 701-725.05.Startup counter • Error history: 701-725.06.Output
725	Error history: Oldest error in the history

25.2 Display of service values (example)

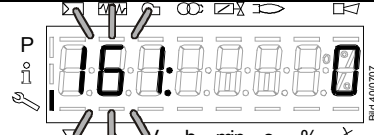
25.2.1 Number of faults



The display shows parameter **161**: flashing on the left, the number of faults that occurred thus far on the right **0**.
Example: Parameter **161**: **0**

To the next parameter  **+** or  **/reset**  **-** Back to the previous parameter.

<1 s

25.2.2 Error history

Refer to chapter *Parameter with index, without direct display/Example of parameter 701: Error history!*





Note

Can be deleted for service (refer to chapter *Parameter list!*)

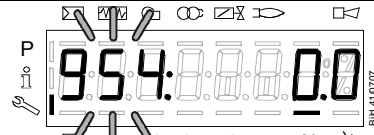
25.2.3 Intensity of flame



The display shows parameter **954**: flashing on the left. On the right, the flame's intensity is displayed as a percentage.
Example: **954**: **0.0**

To the next parameter  **+** or  **/reset**  **-** Back to the previous parameter.

<1 s



Note

Also refer to chapter *Intensity of flame during curve settings.*

25.2.4 End of service level

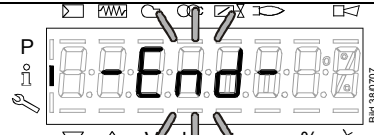

When this display appears, you have reached the end of the service level.
Display **End** appears flashing.

To the start of the service level  **+**  **-** To the end of the service level

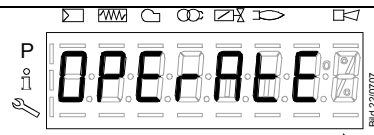

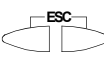
Press  **-** **+** to return to the normal display. **OPERAtE** appears for a short moment.

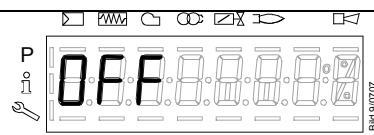

When this display appears, you are back on the normal display and you can change to the next level mode.

26 Parameter level

The parameters stored in the LMV27 can be displayed or changed on the parameter level.

The change to the parameter level requires a password.

Siemens supplies the LMV27 with the factory settings according to *Type summary*.

The OEM can change the Siemens default settings to match his own requirements.

With the LMV27, the LMV27's characteristics are determined primarily through parameter settings. Every time the unit is recommissioned, the parameter settings must be checked. The LMV27 must never be transferred from one plant to another without matching the unit's parameters to the new plant.

Caution!

Parameters and settings may only be changed by **qualified personnel**.

If parameters are changed, responsibility for the new parameter settings is assumed by the person who – in accordance with the access rights – has made parameter changes on the respective access level.

After parameterization, the OEM must check to ensure that safe burner operation is warranted.

The OEM which made the settings is always responsible for the parameters, their settings and compliance of the respective application with the relevant national and international standards and safety regulations, such as EN 267, EN 676, EN 746-2, EN 1643, etc.

Siemens, its suppliers and other Group Companies of Siemens AG do not assume responsibility for special or indirect damage, consequential damage, other damage, or damage resulting from wrong parameter settings.



Warning!

If the factory settings are changed, all changes made must be documented and checked by the OEM.

The OEM is obliged to mark the LMV27 accordingly and to include at least the list of device parameters and settings in the burner's documentation.

Siemens also recommends attaching an additional mark on the LMV27 in the form of an adhesive label. According to EN 298, the label should be easy to read and wipeproof.

The label with a maximum size of 70 mm x 45 mm can be attached to the upper part of the housing.



Example of label:

OEM logo

Type / part no.: 1234567890ABCD

Caution! OEM settings:

Parameter

225 = 30 s (t1)

226 = 2 s (t3)

230 = 10 s (t4)

234 = 0 s (t8)

240 = 1 (repetition)

257 = 2 s (t3n)

TSA = t3n + 0.7 s

259 = 30 s (t11)

260 = 30 s (t12)

26.1 Entry of password



Note

The **OEM's** password must consist of **5** characters, the **heating engineer's** of **4** characters.

		<p>Press button combination to display CodeE.</p>
		<p>When releasing the buttons, 7 bars appear the first of which flashes.</p>
		<p>Press to select a number or letter.</p>
<p>i/reset</p>		
		<p>Press to confirm the value.</p> <p>The value entered changes to a minus sign (-).</p> <p>The next bar starts flashing.</p>
<p>i/reset</p>		
		<p>Press to select a number or letter.</p>
<p>i/reset</p>		<p>After entry of the last character, the password must be confirmed by pressing .</p> <p>Press again to end the password entry.</p> <p>Example: Password consisting of 4 characters.</p>

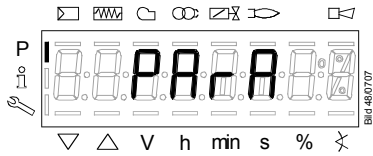

As a confirmation of correct entry, **PArA** appears for maximum 2 seconds.



Note

For entry of passwords or burner IDs, the following numbers and letters can be used:

	= 1		= A		= L
	= 2		= b		= n
	= 3		= C		= o
	= 4		= d		= P
	= 5		= E		= r
	= 6		= F		= S
	= 7		= G		= t
	= 8		= H		= u
	= 9		= I		= Y
	= 0		= J		

26.2 Entry of burner identification

The burner's identification is entered like a password (character by character), but from right to left and ending with «_».

		<p>Parameter 113: flashes.</p> <p>Press to go to editing mode.</p>
		<p>You are on the display for undefined burner identification. 8 bars appear.</p>
		<p>Press or to select a number. Example: Number 3 flashes.</p>
		<p>Press to confirm the value.</p> <p>Make the entry number by number.</p>
		<p>Press or to select the next number. Example: Number 9 flashes.</p>
		<p>After entry of the last number, burner identification must be confirmed by pressing .</p>

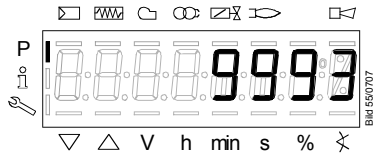

The display no longer flashes.
Example: Burner identification **9993**

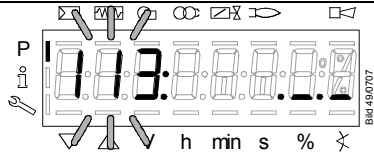
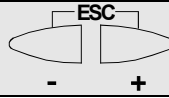

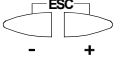
Press  to return to the parameter level.

PArAmeter 113: for burner identification.

26.3 Change of heating engineer's password







Note!

For the OEM to change the heating engineer's password, c: requires entry of the OEM password!

		<p>Press button combination to display 000: Int.</p> <p>Pressing the button takes you to parameter 041 heating engineer's password.</p>
		<p>Parameter 041: flashes.</p> <p>Press to go to level c: for password changes.</p>
		<p>Letter n: for new appears flashing.</p> <p>Proceed as described in chapter <i>Entry of password</i> and enter the new password (4 characters).</p> <p>After entry of the last character, the password must be confirmed by pressing .</p>
		<p>Letter r: for repeat appears flashing.</p> <p>Proceed as described in chapter <i>Entry of password</i> and repeat entry of the new password.</p> <p>After entry of the last character, the password must be confirmed by pressing .</p>
		<p>SEt confirms that the new password has been saved.</p>
		<p>Pressing the button takes you to parameter 041 heating engineer's password.</p>
<p>Continue in the parameter level to the next parameter group 100:</p>		<p>End of the parameter level -End-</p>

26.4 Change of OEM's password







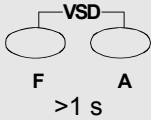
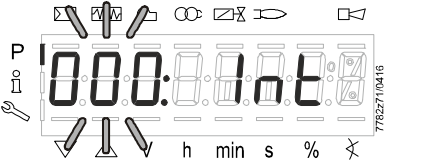

		<p>Parameter 042: flashes.</p> <p>Press  to go to level c: for password changes.</p>
		<p>Letter n: for new appears flashing.</p> <p>Proceed as described in chapter <i>Entry of password</i> and enter the new password (5 characters).</p> <p>After entry of the last character, the password must be confirmed by pressing .</p>
		<p>Letter r: for repeat appears flashing.</p> <p>Proceed as described in chapter <i>Entry of password</i> and repeat entry of the new password.</p> <p>After entry of the last character, the password must be confirmed by pressing .</p>
		<p>SEt confirms that the new password has been saved.</p>
		<p>Parameter 042: flashes again.</p>

26.5 Use of parameter level

The parameters stored in the LMV27 can be displayed and changed on the parameter level.

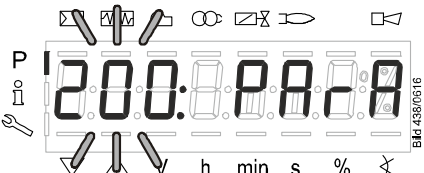
Normally, all parameters have been set by the burner manufacturer – with the exception of those for the fuel train and for air-fuel ratio control.

A description of parameter level **400**, which is used for setting the fuel train and the fuel-air ratio curve, is given in chapter *Fuel / air ratio curves – settings and commissioning*.

		<p>Press button combination  to display 000: Int.</p> <p>With  + , select the parameter group 100: PArA.</p>
		<p>With  + , select the parameter group 200: PArA.</p> <p>Pressing the  /reset button takes you to parameter 201: Burner operating mode.</p>

26.6 Structure of parameter levels

The parameters are assigned to different levels.



Bild 388e/1109

Figure 81: Parameter level structure

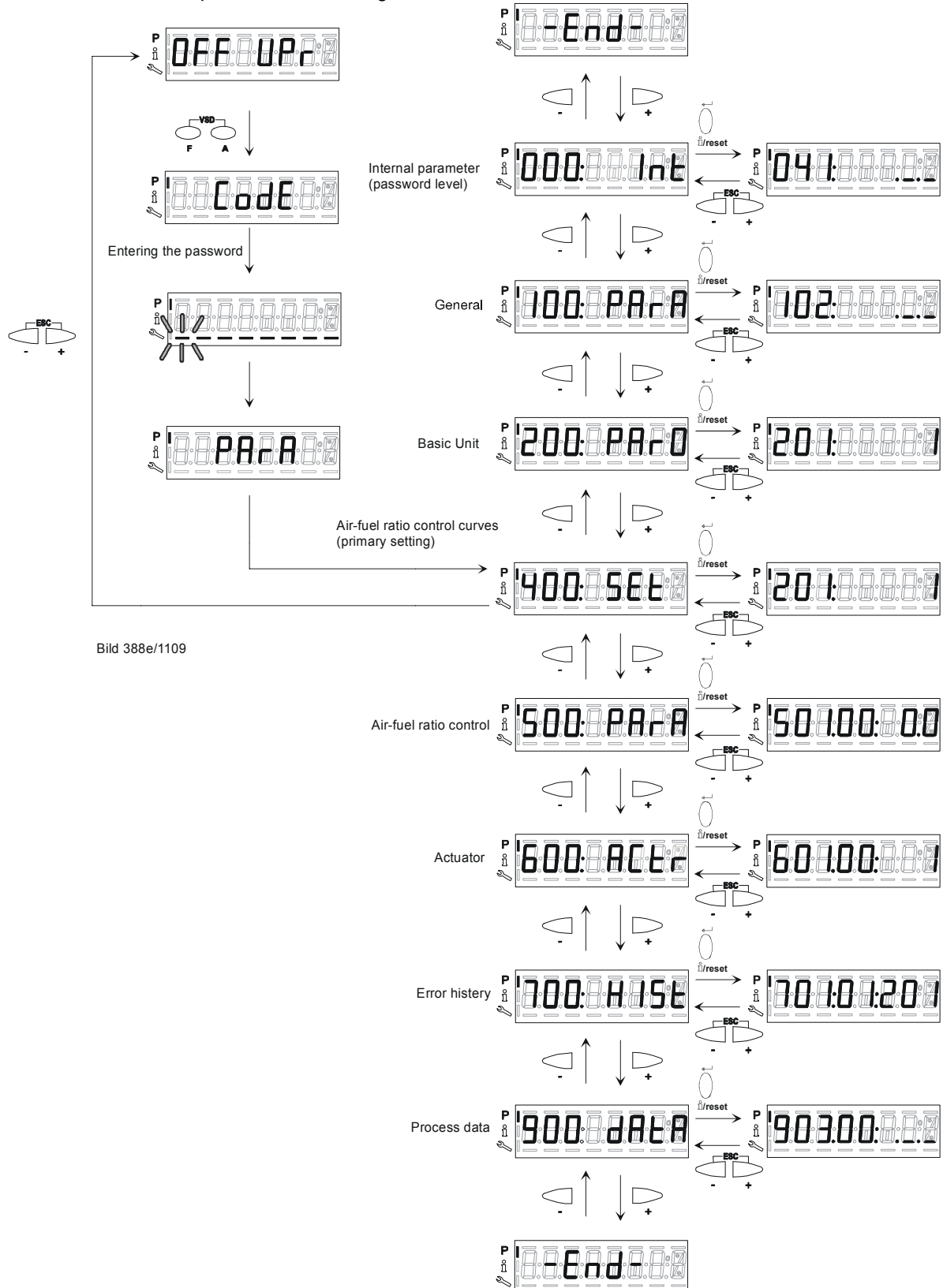

Note

The following sections explain the operating philosophy behind the parameter levels using a number of examples.



Caution!

Pay special attention to chapter **Safety notes on settings and parameter settings!**

26.7 Parameters without index, with direct display

26.7.1 Using the example of parameter 208: Program stop

		<p>PArAmeter level 200: for LMV27.</p>
		<p>Press to go to menu level 200:</p>
		<p>Press + to select <i>Program stop</i>. Display: Parameter 208: flashes, value 0 does not.</p>
		<p>Press to go to editing mode. Display: Program stop time set Here: Value 0 → corresponding to program stop deactivated</p>
		<p>Press or to select the required program stop time.</p> <ul style="list-style-type: none"> 0 = deactivated 1 = prepurge position (phase 24) 2 = ignition position (phase 36) 3 = interval 1 (phase 44) 4 = interval 2 (phase 52) <p>Example: 2 ignition position (phase 36)</p>

Adopt the value!

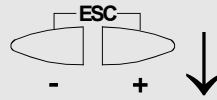
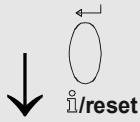

Discard the change!

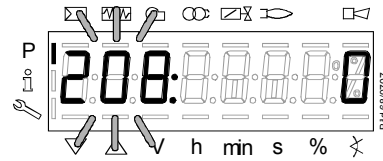
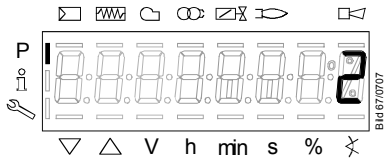

Press  to return to editing mode.

The value set is adopted.



Note

To detect potential display errors, the value is displayed 1 place shifted to the right.

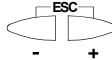
Press  to return to the parameter level.

Display: Parameter **208**: flashes, value **0** does not.

Display: Value **2**

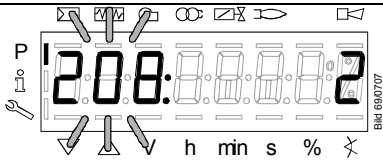
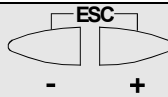

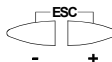
Press  to return to the parameter level.

PArAmeter 208: flashes, value **2** does not.

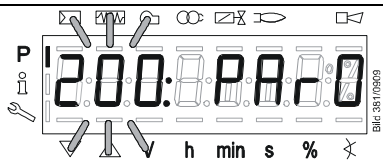
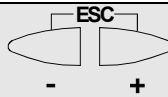

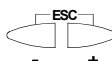
Press  to return to the parameter level.

PArAmeter 200: for LMV27.

To the next parameter level



Back to the previous parameter level

26.8 Parameters without index, with no direct display (with parameters having a value range > 5 digits)

26.8.1 Using the example of parameter 162: Operating hours resettable

		<p>PArAmeter level 100: for general.</p>
		<p>Press to go to menu level 100:</p>
		<p>Press to select <i>Operating hours resettable</i>.</p> <p>Display: Parameter 162: flashes, characters --- do not.</p>
		<p>Press to go to editing mode.</p> <p>Display: 123457</p>
		<p>You can press or to set the number of operating hours to 0.</p> <p>Display: Operating hours 0 flashes</p>

Adopt the value!

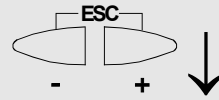
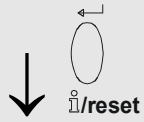

Discard the change!

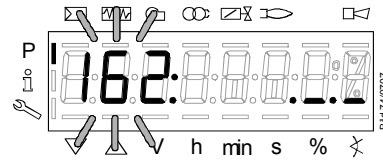
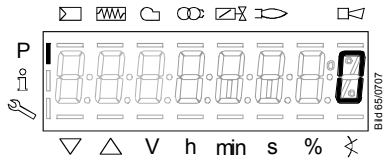

Press  to return to editing mode.

The value set will be adopted.

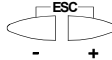

Note
To detect potential display errors, the value is displayed 1 place shifted to the right.

Press  to return to the parameter level.

Display: Parameter **162**: flashes, characters **162** do not.

Display: Value **0**

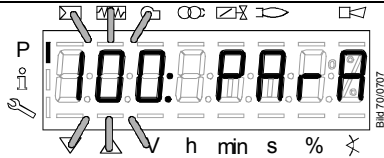
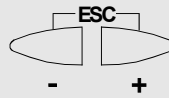

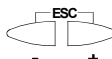
Press  to return to the parameter level.

PARAmeter 100: for general

26.9 Parameter with index, with direct display

26.9.1 Using the example of parameter 501: No-flame positions fuel actuator

		<p>PARAmeter level 500: for fuel / air ratio control.</p>
		<p>Press to go to menu level 500:</p> <p>Display: Parameter 501. flashes, index 00: and value 0.0 do not.</p>
		<p>Press to go to the index.</p> <p>Display: Parameter 501. does not flash, index 00: flashes, value 0.0 does not.</p>
		<p>Press or to select the required index.</p> <ul style="list-style-type: none"> .00 = home position .01 = prepurge position .02 = postpurge position <p>Display: Index 01: for prepurge position flashes, value 0.0 does not.</p>
		<p>Press to go to editing mode.</p> <p>Display: Value 0.0</p>
		<p>Press or to select the required prepurge position.</p> <p>Example: 1.0</p>

Adopt the value!

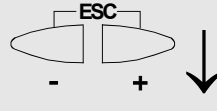
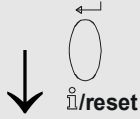

Discard the change!

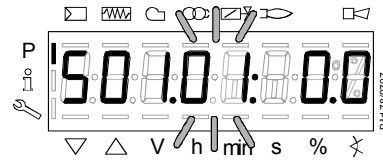
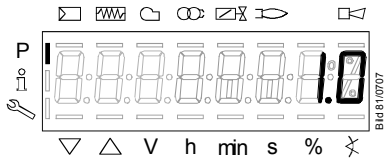

Press  to return to editing mode.

The value set will be adopted.





Note
To detect potential display errors, the value is displayed 1 place shifted to the right.

Press  to return to the index.

Display: Parameter **501**. does not flash, index **01**: flashes, value **0.0** has not changed and does not flash.

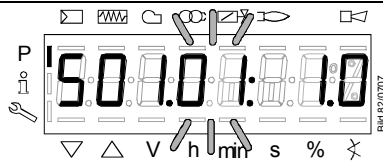
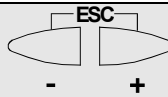
Display: Value **1.0**



Press  to return to the index.

ParAmeter **501**: does not flash, index **01**: flashes, value **1.0** does not.

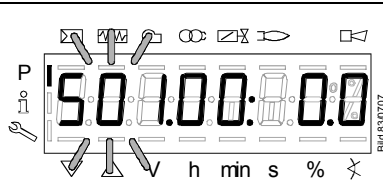
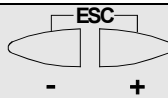

Press  to return to the parameter level.

Display: Parameter **501**. flashes, index **00**: and value **0.0** do not.

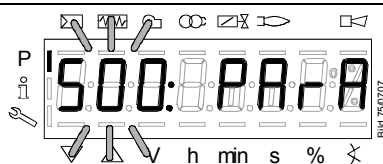
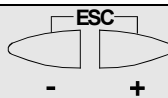

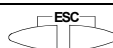
Press  to return to the parameter level.

ParAmeter **500**: for air-fuel ratio control.

26.10 Parameters with index, with no direct display

26.10.1 Using the example of parameter 701: Errors

Refer to chapter *Error code list!*



Note

Can be deleted for service, refer to chapter *Parameter list!*

HIStory 700: for error history.

Press to go to the parameter level.

Press + to select parameter **701**.

Display: Parameter **701**. flashes, index **01**: and value **201** do not.

Press to go to index **01**:

Display: Parameter **701**. does not flash, index **01**: flashes, value **201** does not.

To the next index +

Back to the previous index -

Press + to select the index:

- .01 = error code
- .02 = diagnostic code
- .03 = error class
- .04 = error phase
- .05 = startup counter
- .06 = output

Example:
Parameter **701**., index **05**: for startup counter, diagnostic code **.-.-**

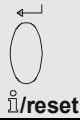

Reset

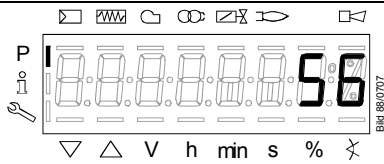

Press Reset to go to display mode.

Display: Value 56

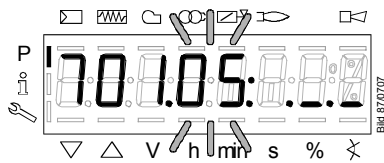
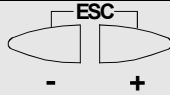

Press - + to return to the index.

Display: Parameter 701. does not flash, index 05: flashes, characters -- do not.

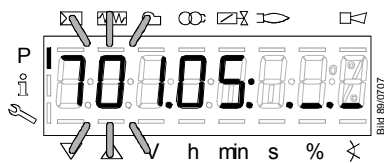
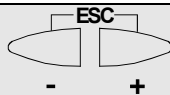

Press - + to return to the parameter level.

Display: Parameter 701. flashes index 05: does not, characters -- do not.

To the next older error



+

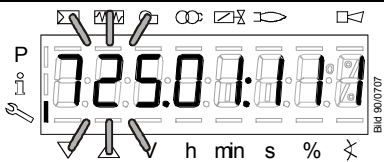

Parameters cover the period of time back to the last error since history was deleted (max. to parameter 725.)

Example:

Parameter 725., index 01:, error code 111

To the next parameter



+



-

Back to the previous parameter.

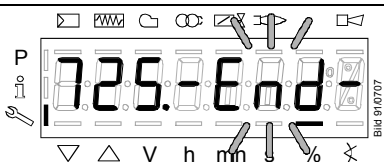

When this display appears, you have reached the end of the error history index.

Display - End - appears flashing.

To the next parameter



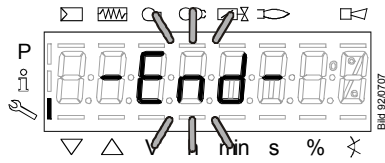

Back to the previous parameter.

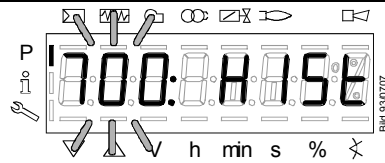
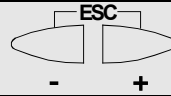

When this display appears, you have reached the end of the error history.

Display **– End –** appears flashing.



Press  to return to the parameter level.

HISt 700: for error history

To the next parameter



Back to the previous parameter.



Note

If you wish, you can delete the error history via parameter 130.

To delete the display, set the parameter to 1 and then to 2.

The error history is deleted when the parameter has returned to 0.

26.11 Fuel / air ratio curves – settings and commissioning

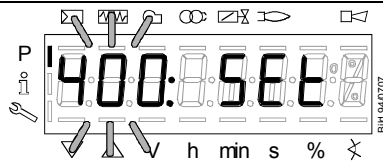

The display shows **400**: flashing on the left, **SEt** appears on the right.

26.11.1 Initial commissioning

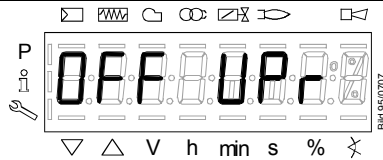

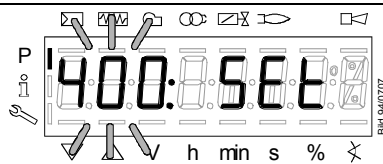
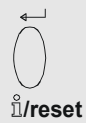

An unprogrammed LMV27 or a LMV27 whose operating mode has been reset or changed displays **OFF UPr**.

For initial commissioning, change to the parameter level (refer to chapter *Operation*).
The settings can then be made on parameter level **400**.

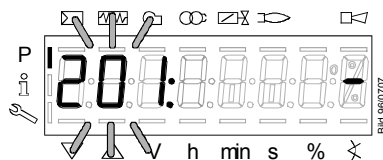
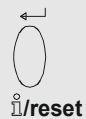

Press  to select parameter **400** for initial commissioning and for setting air-fuel ratio control.



Press  to go to the settings for air-fuel ratio control and parameter **201** for selecting the operating mode.

201: appears flashing.



Note

Ensure that the fuel train is correctly set in compliance with the type of burner used.

No.	Parameter	Actuator controlled	
		Air	Fuel
201	Burner operating mode (fuel train, modulating / multistage, actuators, etc.)		
	-- = undefined (delete curves)	●	●
	1 = gas modulating (G mod)	●	●
	2 = gas modulating with pilot valve 1 (Gp1 mod)	●	●
	3 = gas modulating with pilot valve 2 (Gp2 mod)	●	●
	4 = oil modulating (Lo mod)	●	●
	5 = oil 2-stage (Lo 2 stage)	●	---
	6 = oil 3-stage (Lo 3 stage)	●	---
	7 = gas modulating pneumatic (G mod pneu)	●	---
	8 = gas modulating pneumatic with pilot valve 1 (Gp1 mod pneu)	●	---
	9 = gas modulating pneumatic with pilot valve 2 (Gp2 mod pneu)	●	---
	10 = oil modulating with pilot valve (LoGp mod)	●	●
	11 = oil 2-stage with pilot valve 2 (LoGp 2-stage)	●	---
	12 = oil modulating with 2 fuel valves (Lo mod 2 fuel valves)	●	●
	13 = oil modulating with pilot valve and 2 fuel valves (LoGp mod 2 fuel valves)	●	●
	14 = gas modulating pneumatic without actuator (G mod pneu without actuator, 0 active)	---	---
	15 = gas modulating pneumatic with pilot valve 1 without actuator (Gp1 mod pneu without actuator, 0 active)	---	---
	16 = gas modulating pneumatic with pilot valve 2 without actuator (Gp2 mod pneu without actuator, 0 active)	---	---
	17 = oil 2-stage without actuator (Lo 2-stage without actuator, 0 active)	---	---
	18 = oil 3-stage without actuator (Lo 3-stage without actuator, 0 active)	---	---
	19 = gas modulating only gas actuator (G mod only gas actuator, fuel active)	---	●
	20 = gas modulating with pilot valve 1 only gas actuator (Gp1 mod only gas actuator, fuel active)	---	●
	21 = gas modulating with pilot valve 2 only gas actuator (Gp2 mod only gas actuator, fuel active)	---	●
	22 = oil modulating only oil actuator (Lo mod only oil actuator, fuel active)	---	●
	23 = heavy oil modulating with circulation control (Ho mod separate circulation control ¹⁾)	●	●
	24 = heavy oil 2-stage with circulation control (Ho 2 stage separate circulation control ¹⁾)	●	---
	25 = heavy oil modulation without circulation control (Ho mod without circulation control ¹⁾)	●	●
	26 = heavy oil 2-stage without circulation control (Ho 2 stage without circulation control ¹⁾)	●	---
	27 = heavy oil 3-stage without circulation control (Ho 3 stage without circulation control ¹⁾)	●	---
	28 = gas modulating mechanical only air actuator (G mod mech only fuel active, fuel active) ¹⁾	●	---
	29 = gas modulating mechanical with pilot valve 2 only air actuator (Gp2 mod mech only air actuator, fuel active) ¹⁾	●	---

¹⁾ Selected operating mode is not released for the LMV27.

With select: Error code 210 diagnostic code 0

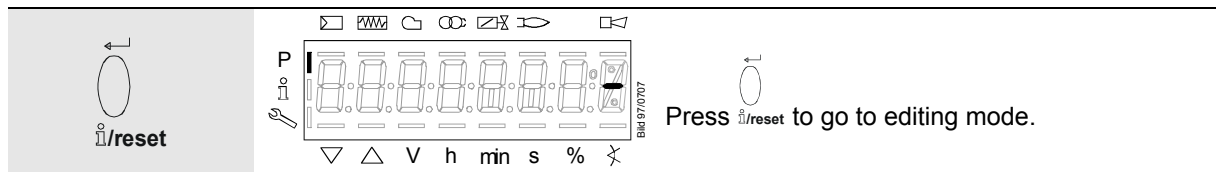

i/reset

Press **i/reset** to go to editing mode.

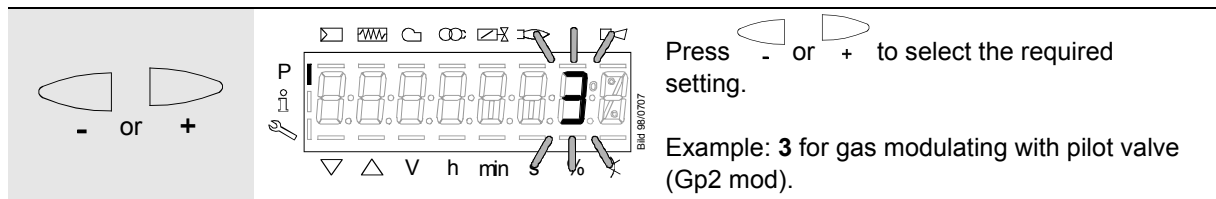

- or **+**

Press **-** or **+** to select the required setting.

Example: **3** for gas modulating with pilot valve (Gp2 mod).

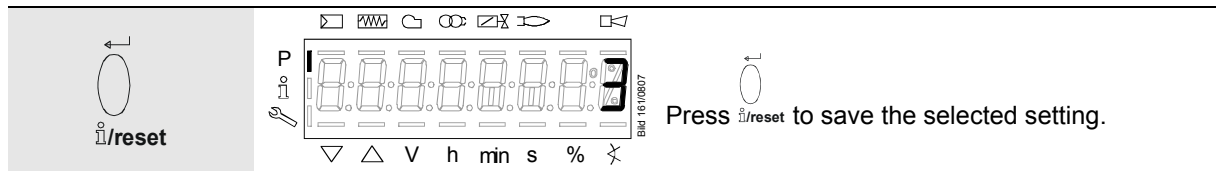

i/reset

Press **i/reset** to save the selected setting.

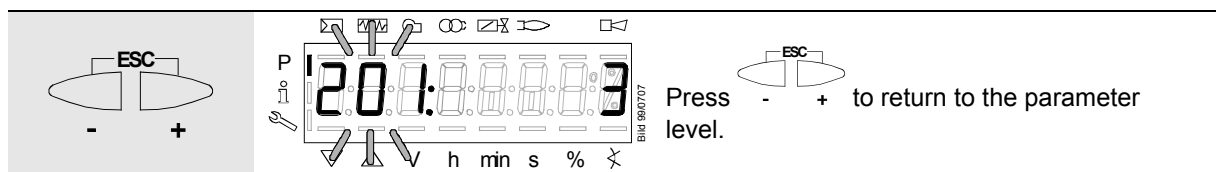

ESC

- **+**

Press **-** **+** to return to the parameter level.

To the next parameter



- For operating modes 1...4, 7...10, 12...16 and 19...22, refer to chapter *Setting curvepoints P0 and P9 for modulating mode («G mod», «Gp1 mod», «Gp2 mod» and «Lo mod»)*
- For operating modes 5, 6, 11, 17 und 18, refer to chapter *Setting the curvepoints for multistage mode («Lo 2 stage» and «Lo 3 stage»)*

26.11.2 Setting curvepoints P0 and P9 for modulating mode («G mod», «Gp1 mod», «Gp2 mod» and «Lo mod»)



Note

Not all actuators used in the following example can be set, depending on the selected operating mode.

Example of «G mod»

		<p>Display P0 appears flashing.</p> <p>Curvepoint for ignition load.</p>
		<p>Keep F depressed.</p> <p>You are now in setting P0 of fuel setting F for ignition position P0.</p>
		<p>Press simultaneously F and - or + to set ignition position P0 of the fuel damper.</p> <p>Example: 30.0</p>
		<p>Release F.</p> <p>The selected value will be adopted.</p> <p>Example: 30.0</p>
		<p>Keep A depressed.</p> <p>You are now in setting P0 of air actuator A for ignition position P0.</p>
		<p>Press simultaneously A and - or + to set ignition position P0 of the air actuator.</p> <p>Example: 22.0</p>
		<p>Release A.</p> <p>The selected value will be adopted.</p> <p>Example: 22.0</p>
		<p>Keep F and A depressed.</p> <p>You are now in setting n0, speed n is for ignition position n0</p>

Press simultaneously **F** and **A** and **-** or **+** to adjust speed **n0** of the load controller.
 Example: **20.0**

Release **F** and **A**.
 The selected value will be adopted.
 Example: **20.0**

To the next curvepoint

Press **+**.
P9 appears blinking.
 Curvepoint for high-fire.
 Same procedure as with **P0**

Note!
 If **-** is pressed first, the display jumps to 90!

To the next curvepoint Back to the previous curvepoint.

Press **+**.
 The display shows **run** (identification of start for setting the curve parameters).

Note!

You now have the option of pressing /reset to proceed with the warm settings (see section *Warm settings for modulating operation «G mod», «Gp1 mod», «Gp2 mod» and «Lo mod»*) or pressing **-** **+** to proceed with the cold settings (see section *Cold settings for «G mod», «Gp1 mod», «Gp2 mod» and «Lo mod»*) of the LMV27.

26.11.3 Setting curvepoints P0 and P9 for «G mod pneu», «Gp1 mod pneu» and «Gp2 mod pneu»

Note

Refer to chapter *Setting curvepoints P0 and P9 for modulating mode («G mod», «Gp1 mod», «Gp2 mod» and «Lo mod»)*! Here, only the air requires adjustment with **A**.

26.11.4 Warm settings for modulating mode («G mod», «Gp1 mod», «Gp2 mod» and «Lo mod»)



Note

With the *warm settings*, the burner is started up after pressing the **Info** button. Air-fuel ratio control can now be accurately set while the flame is present. When traveling along the precalculated curve to high-fire point **P9**, all intermediate curvepoints (**P2...P8**) must be set. Automatic operation is released when – after reaching **P9** – the curve settings are quit by pressing **ESC**. If the curve settings are aborted earlier (**ESC** or shutdown due to fault), start prevention **OFF UPr** continues to be active until all points are set. If required, the gas pressure can be set at the high-fire point. In case the gas pressure is changed, all points must be checked by traveling along the curve downward and – if required – must be readjusted.

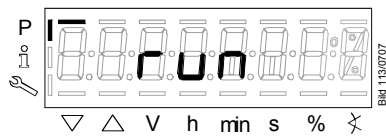

Identification of start for setting the curve parameters.

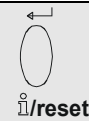

When there is a request for heat.



Note

If, during the time the curve is parameterized, an error occurs which leads to safety shutdown, parameterization of the curve is quit.

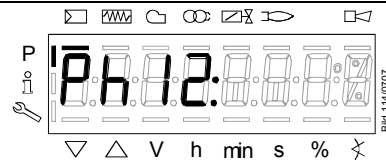

Phase *Standby* (stationary)

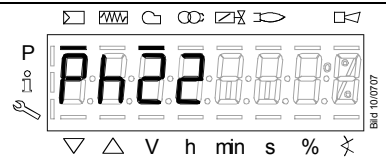

Phase *Fan ramp up* (fan motor = ON, safety valve = ON)

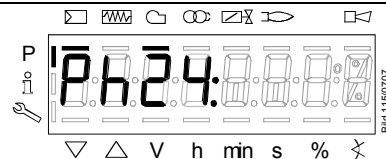

Phase *Traveling to prepurge position*

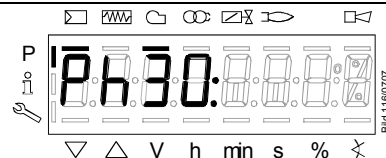

Phase *Prepurging*

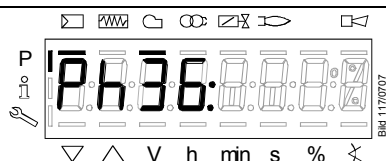

Phase *Traveling to ignition position*

Wait until the burner is operating and symbol \triangle or ∇ is no longer highlighted!
 The startup sequence stops in phase 36 *Traveling to ignition position*.
 The ignition position can be adjusted under *cold* conditions.

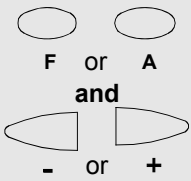
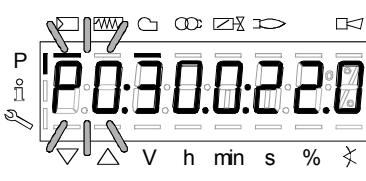



Ignition position **P0** can only be set after symbol \triangle or ∇ is no longer highlighted.

For fuel, keep \textcircled{F} depressed, for air \textcircled{A} .

Press \triangleleft or \triangleright to adjust the value.

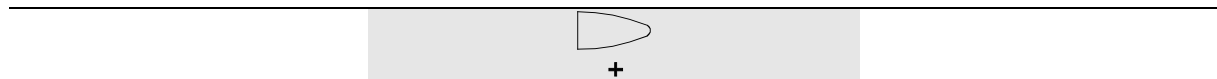
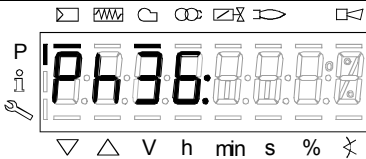
When symbol \triangle or ∇ is no longer highlighted, the next curvepoint **P1** can be selected with \triangleright .

Phase *Traveling to ignition position*

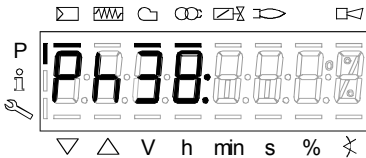

Phase *Preignition*

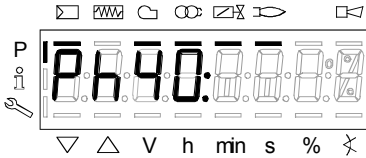

Phase *1st safety time (ignition transformer ON)*

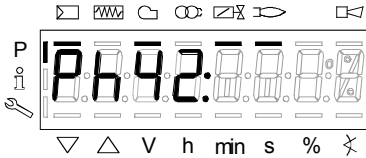

Phase *1st safety time (ignition transformer OFF), preignition time OFF*

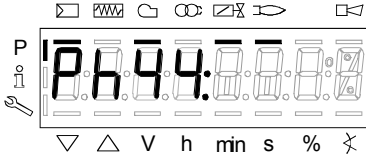

Phase *Interval 1*

Starting the warm settings

F or A
and
- or +

Bid 118/0707

Ignition position **P0** can only be set when symbol \triangle or ∇ is no longer highlighted.

For fuel, keep \circ _F depressed, for air \circ _A.

Press \triangleleft or \triangleright to adjust the value.

When symbol \triangle or ∇ is no longer highlighted, the next curvepoint **P1** can be selected with \triangleright .

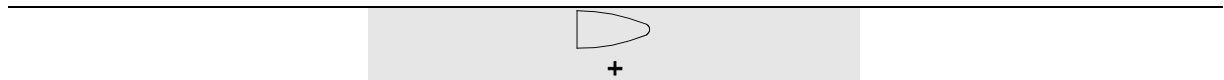

F or A
and
- or +

Bid 123/0707

Low-flame position **P1** can only be set when symbol \triangle or ∇ is no longer highlighted.

The value will be adopted from **P0**.

For fuel, keep \circ _F depressed, for air \circ _A.

Press \triangleleft or \triangleright to adjust the value.

When symbol \triangle or ∇ is no longer highlighted, the next curvepoint **P2** can be selected with \triangleright .



Bid 124/0707

When changing from **P1** to **P2** for the first time, curvepoints **P2...P8** will automatically be calculated and saved.

CALC appears for a short moment.

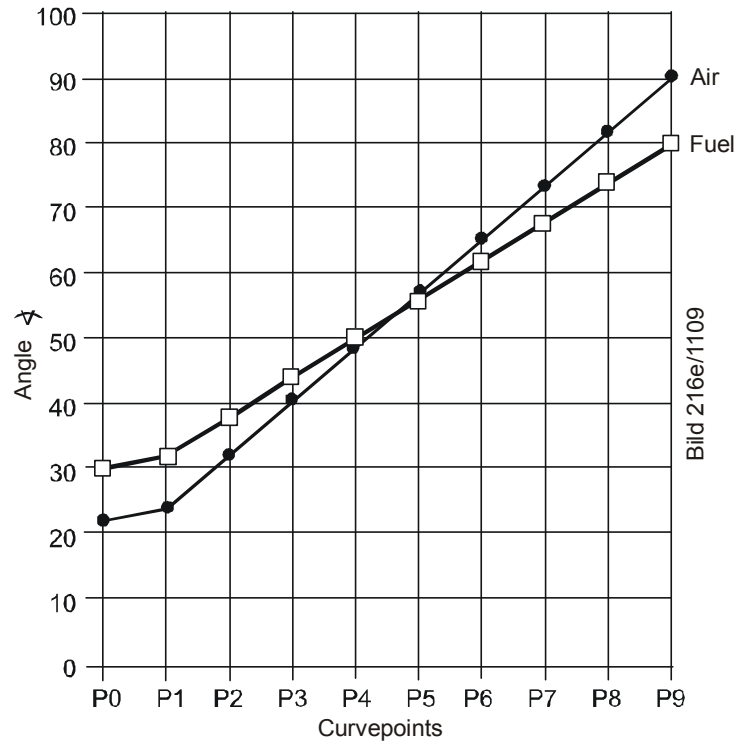

Figure 82: Setting the curvepoints



Note

Curvepoints **P2 to P8** are automatically calculated as a straight line between **P1** and **P9**.

Example 1 = gas modulating

P0, P1 and **P9** are set as described:

Curvepoint	Value 1 fuel	Value 2 air
P0	30.0	22.0
P1	32.0	24.0
P9	80.0	90.0

P2 through P8 have automatically been calculated:

Curvepoint	Value 1 fuel	Value 2 air
P2	38.0	32.3
P3	44.0	40.5
P4	50.0	48.8
P5	56.0	57
P6	62.0	65.3
P7	68.0	73.5
P8	74.0	81.8

Continue the same way with P2 through P9!

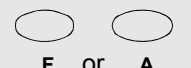
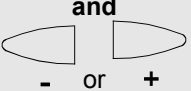
F or A
and

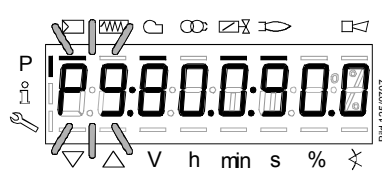
- or +





High-fire position **P9** can only be set when symbol \triangle or ∇ is no longer highlighted. If required, readjust the gas pressure.

For fuel, keep F depressed, for air A .

Press $-$ or $+$ to adjust the value. When symbol \triangle or ∇ is no longer highlighted, the next curvepoint **P8** can be selected with $-$.

After setting the high-fire point (P9), either a change to parameter 546 (automatic operation) can be made (ESC) or all curvepoints can be run through in the reverse order. If the gas pressure is changed, all curvepoints must be checked and – if required – readjusted.





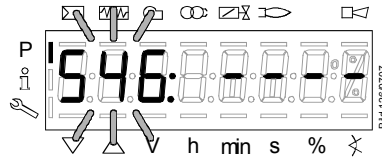

546:

The maximum capacity is displayed. If the display shows - - - -, the maximum capacity has not yet been specified. The LMV27 can be run up to 100%.

You can press  to go to editing mode, enabling you to change the maximum capacity.

To the next parameter

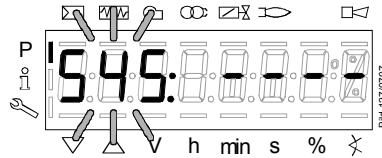



545:

The minimum capacity is displayed. If the display shows - - - -, the minimum capacity has not yet been entered. The LMV27 can be run down to 20%.

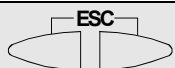
You can press  to go to editing mode, enabling you to change the minimum capacity.

ESC
- +

Completing parameterization of the curve

-

Back to the previous parameter.

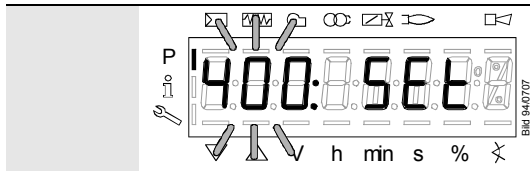

When symbol \triangle or ∇ is no longer highlighted, you can press **ESC** a second time.

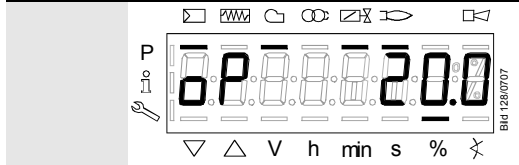
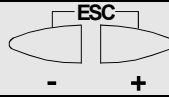

The *warm settings* for air-fuel ratio control by the LMV27 are now completed.

26.11.5 Warm settings for modulating mode («G mod pneu», «Gp1 mod pneu» and «Gp2 mod pneu»)



Note

Refer to chapter *Warm settings for modulating mode («G mod», «Gp1 mod», «Gp2 mod» and «Lo mod»)*! Here, only the air requires adjustment with A .

26.11.6 Cold settings for «G mod», «Gp1 mod», «Gp2 mod» and «Lo mod»



Note

Refer to chapter *Warm settings for modulating mode («G mod», «Gp1 mod», «Gp2 mod» and «Lo mod»)*! With no flame, however, no actuator travel and no automatic operation after the settings have been made.

If **run** is shown in the display, the following must be observed:

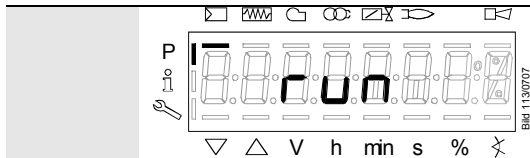

Identification of start for setting the curve.



Note!

You now have the option of pressing ESC to continue with the cold setting for the LMV27.



26.11.7 Cold settings for «G mod pneu», «Gp1 mod pneu» and «Gp2 mod pneu»

Note



Refer to chapter *Warm settings for modulating mode* («G mod», «Gp1 mod», «Gp2 mod» and «Lo mod»)! With no flame, however, no actuator travel and no automatic operation after the settings have been made. Here, only the air requires adjustment with  .

If **run** is shown in the display, the following must be observed:

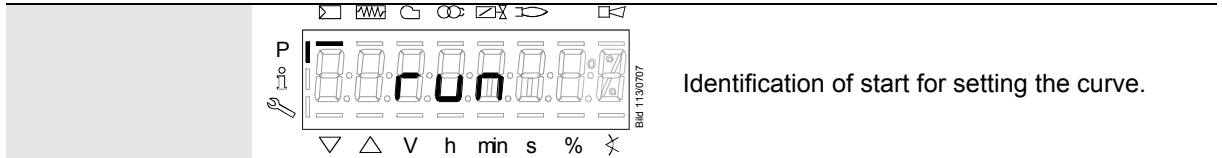

Note!



You now have the option of pressing  -  +  to continue with the cold setting for the LMV27.

26.11.8 Editing the curvepoints



Note

To check the change on the burner, a curvepoint change in the cold settings necessitates a new approach of all curvepoints in the warm settings. After changing the curvepoint, **OFF UPr** appears on the normal display of the AZL2.

To the next curvepoint



or



To select the curvepoint.

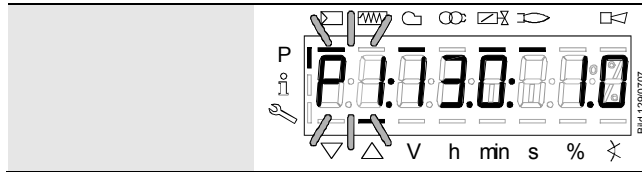

The selected curvepoint is displayed.

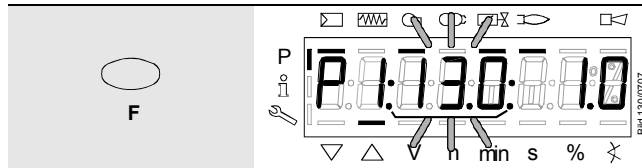

Keep **F** depressed.

The fuel actuator has been selected for editing.

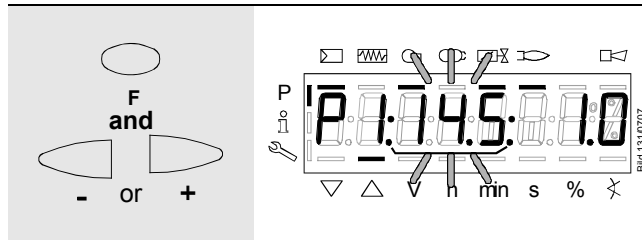

Keep **F** depressed and press **-** or **+** to adjust the fuel actuator.

In the case of warm settings, the actuator follows directly the adjustments made.

The changes are saved.

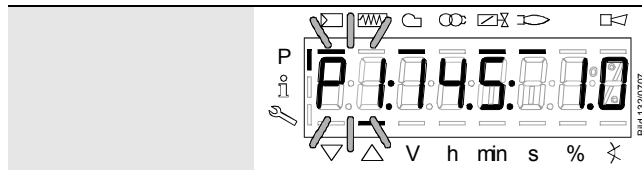

After releasing **F**, the curvepoint is selected again.

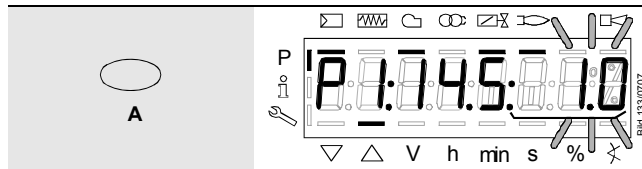

Keep **A** depressed.

The air actuator has been selected for editing.

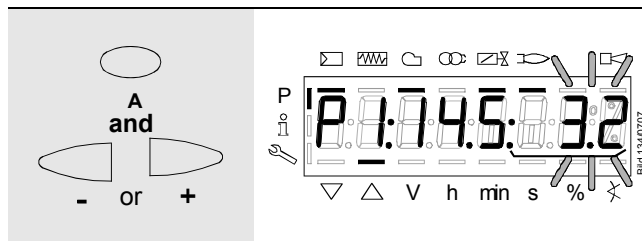

Keep **A** depressed and press **-** or **+** to adjust the air actuator.

In the case of warm settings, the actuator follows directly the adjustments made.

The changes are saved.

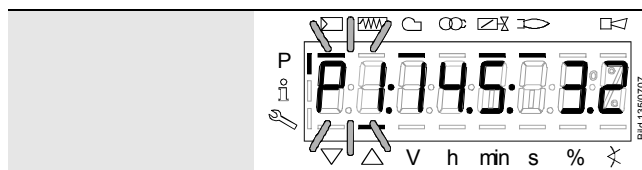

After releasing **A**, the curvepoint is selected again.

To the next curvepoint



Back to the previous curvepoint.

26.11.9 Interpolation of curvepoints



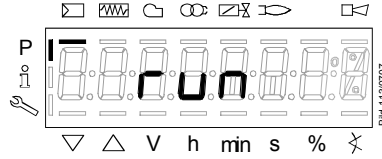

Identification of start for setting the curve parameters.

Example 1 = gas modulating

P0, P1 and P9 are set as described:	Curvepoint	Value 1 fuel	Value 2 air
	P0	30.0	22.0
	P1	32.0	24.0
	P9	80.0	90.0

P2 through P8 have automatically been calculated:	Curvepoint	Value 1 fuel	Value 2 air
	P2	38.0	32.3
	P3	44.0	40.5
	P4	50.0	48.8
	P5	56.0	57
	P6	62.0	65.3
	P7	68.0	73.5
	P8	74.0	81.8

P5 shall now be changed:



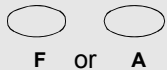



F or A

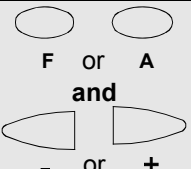

Keep F or A depressed.

Example: F



F or A and - or +

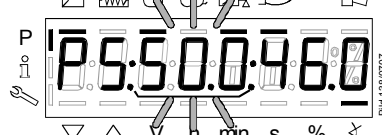

Press - or + to change the value as required.

Example: 50.0

F and A and - or +

Press or to change the value as required.
Example: **00.0**

F OR A

Release or .
The required value will be adopted.
Example: **P5:50.0:46.0**

>3 s

Keep depressed for >3 s.
CALC appears.

The display jumps to **P6**.

All curvepoints from **P5 to P9** have now been automatically recalculated (linear interpolation):

Curvepoint	Value 1 fuel	Value 2 air
P5	50.0	46.0
P6	57.5	57.0
P7	65.0	68.0
P8	72.0	79.0
P9	80.0	90.0

>3 s

Keep depressed for >3 s.
CALC appears.

The display jumps to **P4**.

All curvepoints from **P1 to P5** have now been automatically recalculated (linear interpolation):

Curvepoint	Value 1 fuel	Value 2 air
P5	50.0	46.0
P4	45.5	40.0
P3	41.0	35.0
P2	36.5	29.5
P1	32.0	24.0

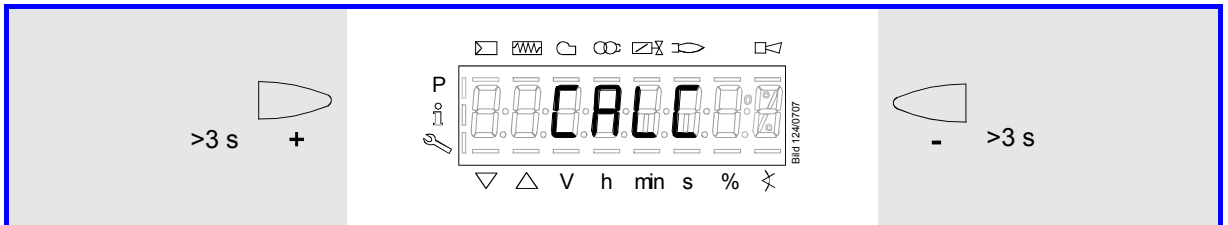

If it is not only the current curvepoint that shall be changed, but all other curvepoints in the direction of travel as well, a new straight line from the current curvepoint to **P9** (press +) or **P1** (press -) can be calculated by a long push on - or + .

Display **CALC**

Example of presentation

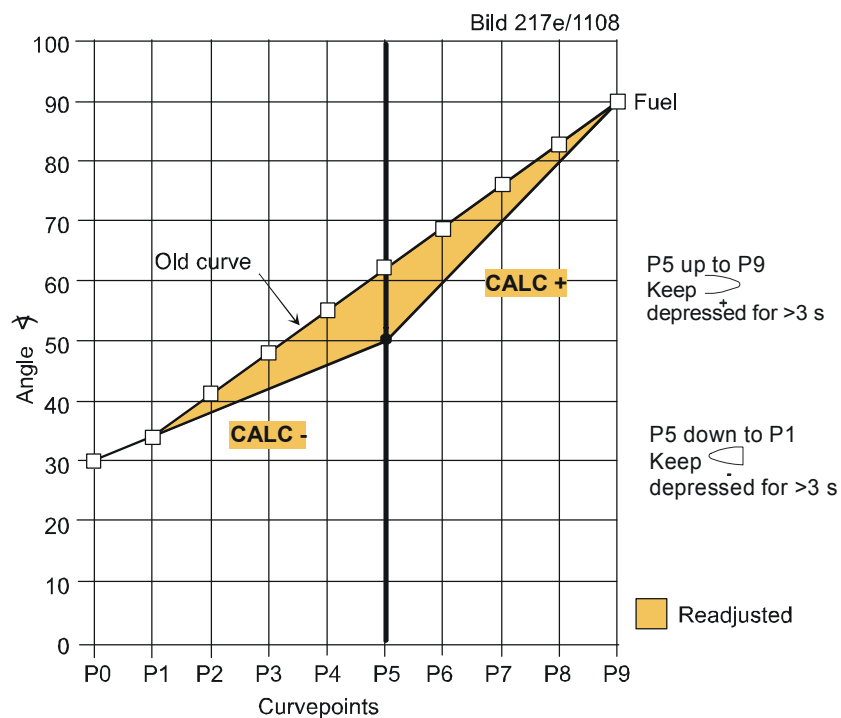

Figure 83: Changing several curvepoints



Note

Due to interpolation, a number of curvepoints change. To be able to make a check on the burner itself, the changed curvepoints must be approached in the warm settings. If these curvepoints have not yet been completely approached, **OFF UP** appears on the normal display of the AZL2.

26.11.10 Setting of curvepoints for multistage mode («Lo 2 stage» and «Lo 3 stage»)

Example of «Lo 2 stage»

		<p>P0 appears flashing.</p> <p>Curvepoint for ignition load.</p>
		<p>Keep A depressed.</p> <p>You are now at P0 of air actuator A.</p>
		<p>Press simultaneously A and - or + to adjust ignition position P0 of the air actuator.</p> <p>Example: 20.0</p>
		<p>Now, release A.</p> <p>The selected value will be adopted.</p> <p>Example: 20.0</p>
		<p>Identification of start for setting the curve parameters.</p>



Note!

You now have the option of pressing **reset** to proceed with the warm settings (see section *Warm settings for modulating operation* «G mod», «Gp1 mod», «Gp2 mod» and «Lo mod») or pressing **ESC** to proceed with the cold settings (see section *Cold settings for* «G mod», «Gp1 mod», «Gp2 mod» and «Lo mod») of the LMV27.

26.11.11 Warm settings for «Lo 2 stage» and « Lo 3 stage»

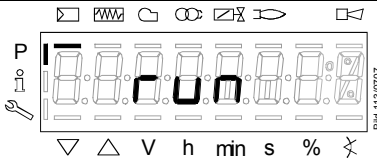

Identification of start for setting the curve parameters.



Provided the load controller is enabled!

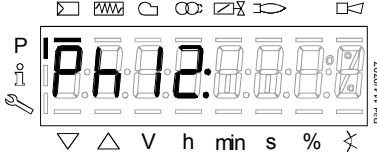

Phase *Standby* (stationary)

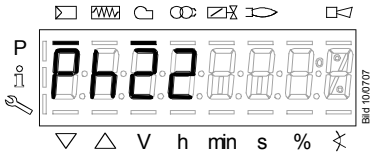

Phase *Fan ramp up* (fan motor = ON, safety valve = ON)

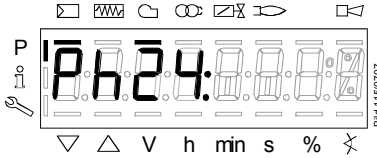

Phase *Traveling to prepurge position*

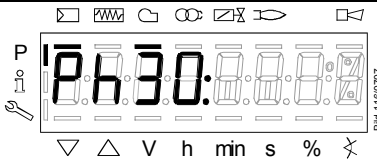

Phase *Prepurging*



Phase *Traveling to ignition position*

Wait until the burner is operation and symbol \triangle or ∇ is no longer highlighted!
 The startup sequence stops in Phase 36 *Traveling to ignition position*.
 The ignition position can be adjusted under *cold* conditions.

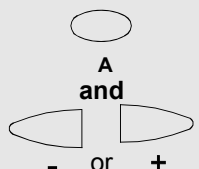
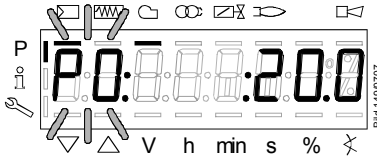
Ignition position **P0** can be set only when symbol \triangle or ∇ is no longer highlighted.

Keep A depressed.

Press $-$ or $+$ to adjust the value.

When symbol \triangle or ∇ is no longer highlighted, the next curvepoint **P1** can be selected with + .



+

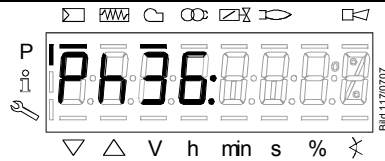

Phase *Traveling to ignition position*

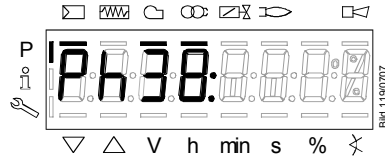

Phase *Preignition*

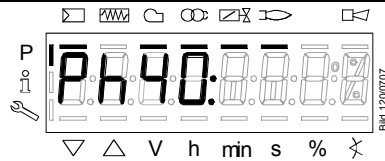

Phase *1st safety time (ignition transformer ON)*

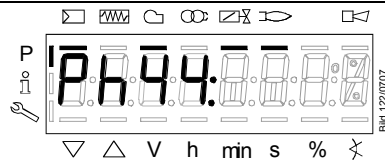

Phase *Interval 1*

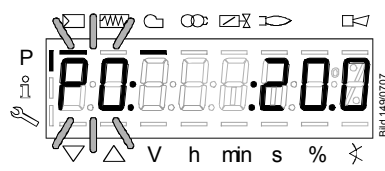
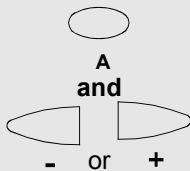

Ignition position **P0** can be set only when symbol \triangle or ∇ is no longer highlighted.

Keep **A** depressed.

Press **-** or **+** to adjust the value.

When symbol \triangle or ∇ is no longer highlighted, the next curvepoint **P1** can be selected with **+**.



+

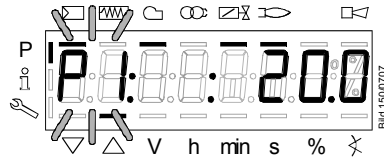
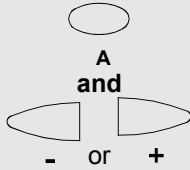

Low-fire position **P1** can be set only when symbol \triangle or ∇ is no longer highlighted.

Set stage 1 **P1**.

Fuel valve **V1** is switched on.

Keep A depressed.

Press $-$ or $+$ to adjust the value.

When symbol \triangle or ∇ is no longer highlighted, the next curvepoint **P2on** can

be selected with $+$.

To the next curvepoint

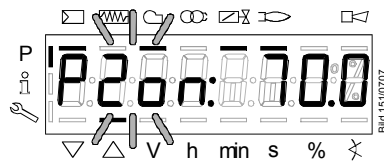
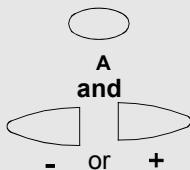

Curvepoint **P2on** can be set only when symbol \triangle or ∇ is no longer highlighted.

Set switch-on point stage 2 **P2**.

Fuel valve **V2** is still off.

Keep A depressed.

Adjust the value with $-$ or $+$.

When symbol \triangle or ∇ is no longer highlighted, the next curvepoint **P2_d** can

be selected with $+$.

To the next curvepoint



Back to the previous curvepoint.

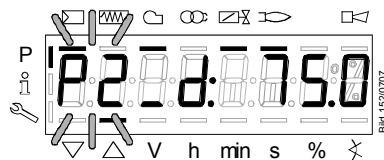
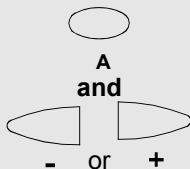

Curvepoint **P2_d** can be set only when symbol \triangle or ∇ is no longer highlighted.

Fuel valve **V2** is still off and the LMV27 remains at curvepoint **P2on**. Presetting of operating stage **P2** with no travel, aimed at cutting the operating time if there is shortage of air.

Keep A depressed.

Press $-$ or $+$ to adjust the value.

When symbol \triangle or ∇ is no longer highlighted, the next curvepoint **P2** can be

selected with $-$.

To the next curvepoint



Back to the previous curvepoint.

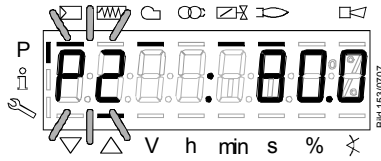
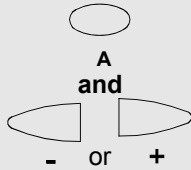

Curvepoint **P2** can only be adjusted when symbol \triangle or ∇ is no longer highlighted.

Fuel valve **V2** will be switched on.

Keep A depressed.

Press $-$ or $+$ to adjust the value.

When symbol \triangle or ∇ is no longer highlighted, the next curvepoint **P2of** can be selected with $-$.



Back to the previous curvepoint.

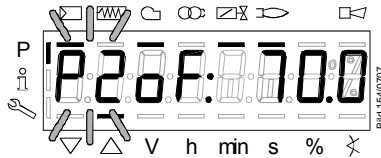

Curvepoint **P2of** is now adjusted.

The LMV27 remains at P2.

Adjust the switch-off point with no travel.

Now, the curvepoint is approached dynamically when traveling from **P2** to **P1**.

When symbol \triangle or ∇ is no longer highlighted, the next curvepoint **P1** can be selected with $-$.

To the next curvepoint



Back to the previous curvepoint.

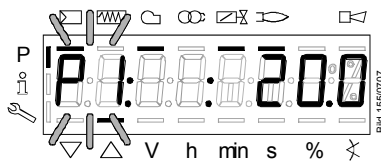

Automatic mode will be released when, after reaching **P1**, the curve settings are quit with **ESC**.

If the settings are aborted earlier (**ESC** or shutdown due to fault), start prevention **OFF UPr** is still active until all curvepoints are set.

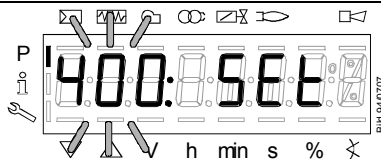
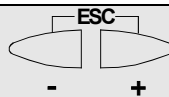

When symbol \triangle or ∇ is no longer highlighted, **ESC** can be pressed a second time.

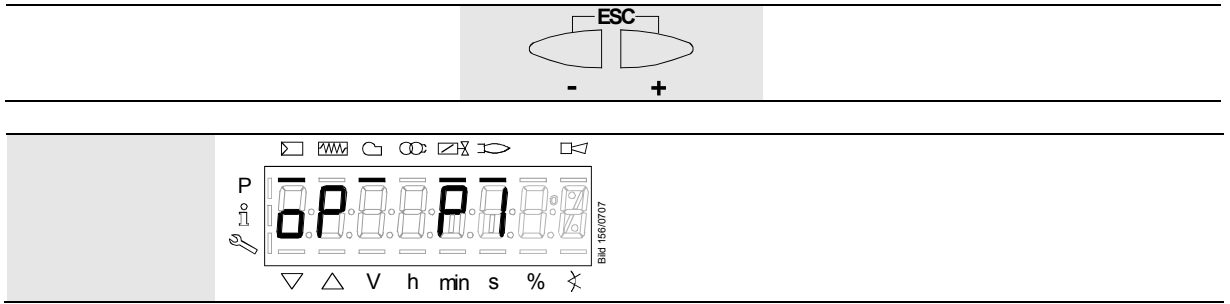

The *warm settings* for air-fuel ratio control of the LMV27 have now been configured.



26.11.12 Cold settings for multistage mode («Lo 2 stage» and «Lo 3 stage»)

Note
 Refer to chapters *Warm settings for «Lo 2-stage» and «Lo 3-stage»!* But with no flame, no actuator travel and no automatic operation after the settings have been made.

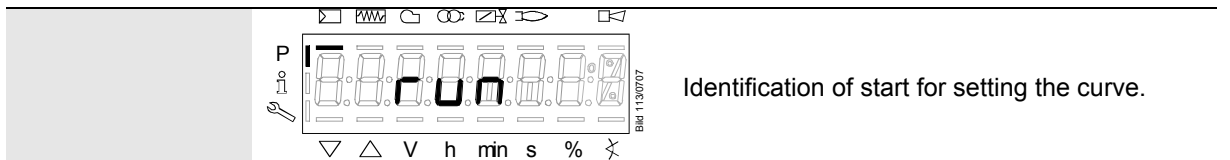
If **run** is shown in the display, the following must be observed:



Identification of start for setting the curve.

Note!
 You now have the option of pressing  to continue with the cold setting for the LMV27.

26.11.13 Intensity of flame during curve settings

When setting the curve and the curvepoint is displayed, you can press  to show the intensity of flame. When pressing the button for >1 s, a change to parameter 954 is made; when releasing the button, you return to the curvepoint.

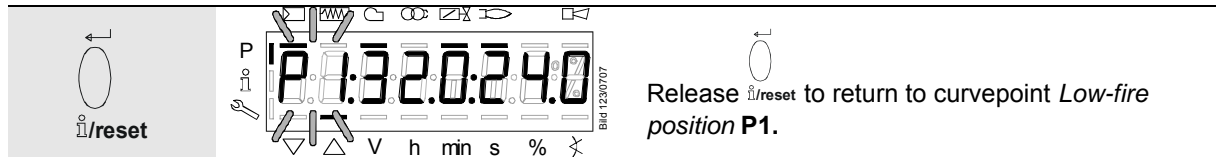
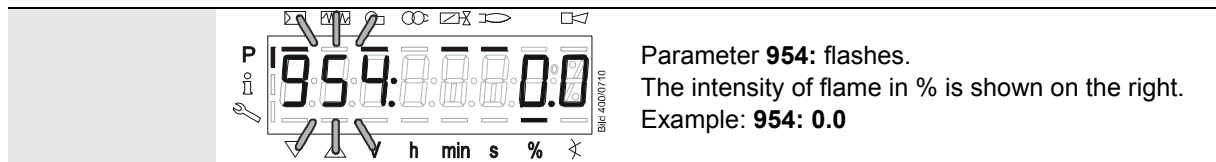
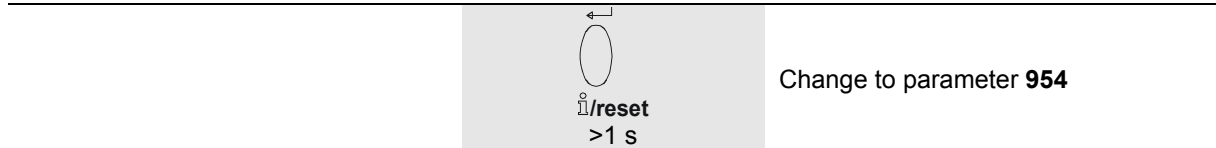
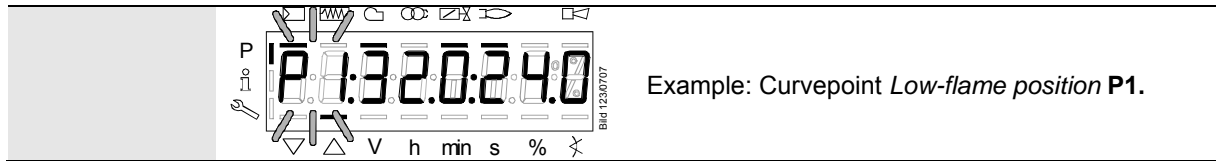

27 Parameter list

Abbreviations for password level:

GA	Building automation
HF	Heating engineer
HF (GA)	Heating engineer (building automation)
IS	Info / service
OEM	Manufacturer of the individual product

Par. no.	Parameter	Number of elements	Type	Edit	Value range		Increment	Default setting		Password level	
					Min.	Max.		Write	Read		
000	Internal parameters										
041	Password heating engineer (HF) (4 characters)	1	Std_u16	Edit	0	65535	1			OEM	OEM
042	Password OEM (5 characters)	1	Std_u16	Edit	0	65535	1			OEM	OEM
050	Start backup / restore via AZL2 / ACS410 PC software (set parameter to 1) Index 0: Create backup Index 1: Execute restore Error diagnostics via negative values (see error code 137)	2	Std_s8	Edit	-99	50	1	0; 0		HF	HF
055	Burner identification of AZL2 backup data set	1	Std_s32	Read only	0	99999999	1	0		---	HF
056	ASN extraction of AZL2 backup data set	8	Std_u8	Read only	0	127	1	0		---	HF
057	Software version when creating the AZL2 backup data set	1	Hex_16	Read only	0x100	0xFFFF9	1	0		---	HF
100	General										
102	Identification date	1	Date	Read only	0	255	1			---	IS
103	Identification number	1	Std_u16	Read only	0	65535	1			---	IS
104	Preselected parameter set: Customer code	1	Std_u8	Read only	0	255	1	9		---	IS
105	Preselected parameter set: Version	1	Hex_16	Read only	0	0xFFFF	1	V 01.12		---	IS
107	Software version	1	Hex_16	Read only	0x100	0xFFFF9	1	V 03.70		---	IS
108	Software variant	1	Std_u8	read only	0	255	1	1		---	IS
111	ASN extraction for verification with the AZL2 backup data set	8	Std_u8	Read only	0	127	1	0		---	HF
113	Burner identification	1	Std_s32	Edit	0	99999999	1	undefined		HF	IS
121	Manual output Undefined = automatic mode	1	Output	Edit / clear	0%	100%	0,1%	undefined		IS	IS
123	Minimum output positioning step Index 0 = output building automation	3	Power	Edit	0%	100%	0,1%	Index 0	Value 0%	HF	HF

Par. no.	Parameter	Number of elements	Type	Edit	Value range		Increment	Default setting		Password level	
					Min.	Max.		Write	Read		
	Index 1 = output external load controller analog Index 2 = Power of external load controller contacts							1 2	1% 0%		
124	Start loss-of-flame test (TÜV test) (set parameter to 1) (shutdown of fuel valves → loss of flame) Error diagnostics via negative values (see error code 150)	1	Std_s8	Edit	-6	1	1	0		HF	HF
125	Mains frequency 0 = 50 Hz 1 = 60 Hz	1	Selection	Edit	0	1	1	0		HF	HF
126	Display brightness	1	Std_u8	Edit	0%	100%	1%	75%		HF	HF
127	Timeout via menu operation	1	Std_u8	Edit	10 min	120 min	1 min	30 min		OEM	OEM
128	Fuel meter: Pulse valency [pulses / volume unit]	1	Std_u16	Edit	0	400	0,01	0		HF	HF
130	Delete display of error history To delete the display: Set the parameter to 1, then to 2 Response 0: Job successful Response: -1: Timeout of 1_2-Sequence	1	Std_s8	Edit	-5	2	1	0		HF	HF
133	Default output at TÜV test Invalid = TÜV test at active output 20...100 = low-fire...high-fire or stage 1 / stage 2 / stage 3 P1...P3 = stage 1...stage 3	1	Power	Edit / clear	20%	100%	0,1%	undefined		HF	HF
141	Operating mode building automation 0 = off 1 = Modbus 2 = reserved	1	Selection	Edit	0	2	1	0		HF	HF
142	Setback time in the event of communication breakdown Setting value: 0 = deactivated 1...7200 s	1	Std_u16	Edit	0 s	7200 s	1 s	120 s		HF (GA)	HF (GA)
143	Reserved	1	Std_u8	Edit	1	8	1	1		HF	IS
144	Reserved	1	Std_u16	Edit	10 s	60 s	1 s	30 s		HF	HF
145	Device address for Modbus of LMV27 Setting values 1...247	1	Std_u8	Edit	1	247	1	1		HF	HF
146	Setting of Baud rate for Modbus communication 0 = 9600 1 = 19200	1	Selection	Edit	0	1	1	1		HF	HF

Par. no.	Parameter	Number of elements	Type	Edit	Value range		Increment	Default setting	Password level	
					Min.	Max.			Write	Read
147	Setting of parity for Modbus communication 0 = none 1 = odd 2 = even	1	Selection	Edit	0	2	1	0	HF	HF
148	Default output if communication with building automation is interrupted Setting values For modulation operation the setting range is as follows: 0...19.9 = burner off 20...100 = 20...100% burner rating (20 = low-fire position) For multistage operation apply to setting range: 0 = burner OFF P1...P3 = stage 1...stage 3 Invalid = no output predefined by the building automation system in the event of communication breakdown Default setting: <i>Invalid</i>	1	Output	Edit / clear	0%	100%	0,1%	undefined	HF (GA)	HF (GA)
161	Number of faults	1	Std_u16	Read only	0	65535	1	0	---	IS
162	Operating hours resettable	1	Std_s32	Reset	0 h	999999 h	1 h	0 h	IS	IS
163	Operating hours LMV27 on supply	1	Std_s32	Read only	0 h	999999 h	1 h	0 h	---	IS
164	Number of startups resettable	1	Std_s32	Reset	0	9999999	1	0	IS	IS
166	Total number of startups	1	Std_s32	Read only	0	9999999	1	0	IS	IS
167	Fuel volume resettable (m ³ , l, ft ³ , gal)	1	Std_s32	Reset	0	99999999	1	0	IS	IS
186	Software drop out delay time of flame signal (100 ms) Index 0 = QRB / QRC (0 = deactivated, >1 = activated) Index 1 = ION / QRA (0 = deactivated, >3 = activated) (only 200 ms-steps)	2	Std_u8	Edit	0	20	1	0; 0	OEM	OEM
190	Postpurging in lockout position 0 = deactivate (no-load position) 1 = active (postpurge position) When active, the <i>Alarm in the event of start prevention</i> function is only possible to a limited extent!	1	Selection	Edit	0	1	1	0	HF	HF
194	Repetition limit no flame at the end of safety time 1 = no repetition	3	Std_u8	Edit	1	4	1	1	OEM	OEM

Par. no.	Parameter	Number of elements	Type	Edit	Value range		Increment	Default setting	Password level	
					Min.	Max.			Write	Read
	2...4 = 1...3 repetitions Recharging time: Entering into operation									
196	Repetition limit air pressure failure 1 = no repetition 2 = 1 repetition 3 = 2 repetitions Recharging time: End of <i>Shutdown</i> phase	1	Std_u8	Edit	1	2	1	1	OEM	OEM
199	Repetition limit value actuators 1 = no repetition 2 = 1 repetition 3 = 2 repetitions	1	Std_u8	Edit	1	3	1	3	OEM	OEM
200	Basic unit LMV27									
201	Burner operating mode (fuel train, modulating / multistage, actuators, etc.) -- = undefined (delete curves) 1 = G mod 2 = Gp1 mod 3 = Gp2 mod 4 = Lo mod 5 = Lo 2-stage 6 = Lo 3-stage 7 = G mod pneu 8 = Gp1 mod pneu 9 = Gp2 mod pneu 10 = LoGp mod 11 = LoGp 2-stage 12 = Lo mod 2 fuel valves 13 = LoGp mod 2 fuel valves 14 = G mod pneu without actuator 15 = Gp1 mod pneu without actuator 16 = Gp2 mod pneu without actuator 17 = Lo 2-stage without actuator 18 = Lo 3-stage without actuator	1	Selection	Edit / clear	1	29	1	undefined	HF	HF (GA)

Par. no.	Parameter	Number of elements	Type	Edit	Value range		Increment	Default setting	Password level	
					Min.	Max.			Write	Read
	19 = G mod gas actuator only 20 = Gp1 mod gas actuator only 21 = Gp2 mod gas actuator only 22 = Lo mod oil actuator only 23 = Ho mod separate circulation control ¹⁾ 24 = Ho 2-stage separate circulation control ¹⁾ 25 = Ho mod. without circulation control ¹⁾ 26 = Ho 2-stage without circulation control ¹⁾ 27 = Ho 3-stage without circulation control ¹⁾ 28 = G mod mech air actuator only ¹⁾ 29 = Gp2 mod mech air actuator only ¹⁾ ¹⁾ Selected operating mode is not released for the LMV27: With select: Error code 210 diagnostic code 0									
205	Function <i>Load controller contacts staged</i> 0 = standard 1 = stages interchanged	1	Std_u8	Edit	0	1	1	0	OEM	OEM
208	Program stop 0 = deactivated 1 = prepurge position (phase 24) 2 = ignition position (phase 36) 3 = interval 1 (phase 44) 4 = interval 2 (phase 52)	1	Selection	Edit	0	4	1	0	HF (GA)	HF (GA)
210	Alarm in the event of start prevention 0 = deactivated 1 = activated	1	Selection	Edit	0	1	1	0	HF	HF
211	Fan ramp up time	1	Time	Edit	2 s	60 s	0,2 s	2 s	HF	HF
212	Maximum time down to low-fire	1	Time	Edit	0,2 s	10 min	0,2 s	45 s	HF	HF
213	Waiting time until home run	1	Time	Edit	2 s	60 s	0,2 s	2 s	OEM	OEM
214	Maximum time start release	1	Time	Edit	0,2 s	10 min	0,2 s	25 s	OEM	OEM
215	Repetition limit safety loop 1 = no repetition 2...15 = 1...14 number of repetitions 16 = constant repetition Recharging time: Every 24 hours	1	Std_u8	Edit	1	16	1	16	HF	HF
217	Maximum waiting time for detection of detector or pressure	1	Time	Edit	5 s	10 min	0,2 s	30 s	OEM	OEM

Par. no.	Parameter	Number of elements	Type	Edit	Value range		Increment	Default setting	Password level	
					Min.	Max.			Write	Read
	switch signal (e.g. home run, preignition)									
221	Gas: Active detector flame evaluation 0 = QRB / QRC 1 = ION / QRA	1	Selection	Edit	0	1	1	1	HF	HF
222	Gas: Prepurging 0 = inactive 1 = active	1	Selection	Edit	0	1	1	1	HF	HF
223	Repetition limit gas pressure switch-min 1 = no repetition 2...15 = 1...14 number of repetitions 16 = constant repetition Recharging time: After the <i>Operation</i> phase 1	1	Std_u8	Edit	1	16	1	16	HF	HF
225	Gas: Prepurge time	1	Time	Edit	20 s	60 min	0,2 s	20 s	HF	HF
226	Gas: Preignition time	1	Time	Edit	0,4 s	60 min	0,2 s	2 s	HF	HF
227	Gas: First safety time	1	Time	Edit	1 s	10 s	0,2 s	3 s	OEM	OEM
229	Gas: Time to respond to pressure faults within first and second safety time	1	Time	Edit	0,4 s	9,6 s	0,2 s	1,8 s	OEM	OEM
230	Gas: Interval 1	1	Time	Edit	0,4 s	60 s	0,2 s	2 s	HF	HF
231	Gas: Second safety time	1	Time	Edit	1 s	10 s	0,2 s	3 s	OEM	OEM
232	Gas: Interval 2	1	Time	Edit	0,4 s	60 s	0,2 s	2 s	HF	HF
233	Gas: Afterburn time	1	Time	Edit	0,2 s	60 s	0,2 s	8 s	HF	HF
234	Gas: Postpurge time (no extraneous light test)	1	Time	Edit	0,2 s	108 min	0,2 s	0,2 s	HF	HF
235	Gas: Air pressure switch 1 = active 2 = active, except phase 60...66 / 70...72 (pneumatic operation only)	1	Selection	Edit	1	2	1	1	OEM	HF
236	Gas: Input pressure switch-min 1 = pressure switch-min before fuel valve V1 (default setting) 2 = valve proving via pressure switch-min (between fuel valve V1 and fuel valve V2) 3 = pressure switch-min after fuel valve V2	1	Selection	Edit	1	3	1	1	OEM	HF
237	Gas: Input pressure switch-max / POC 1 = pressure switch-max 2 = POC 3 = pressure switch valve proving	1	Selection	Edit	1	4	1	1	HF	HF

Par. no.	Parameter	Number of elements	Type	Edit	Value range		Increment	Default setting	Password level	
					Min.	Max.			Write	Read
	4 = not used									
240	Repetition limit loss of flame 1 = no repetition 2 = 1 repetition Recharging time: After the <i>Operation</i> phase 1  Note! Parameters 240 and 280 refer to the same value. This means that no separate setting is possible for oil / gas or fuel 0 / fuel 1.	1	Std_u8	Edit	1	2	1	2	OEM	OEM
241	Gas: Execution valve proving 0 = No valve proving 1 = Valve proving on startup 2 = Valve proving on shutdown 3 = Valve proving on startup and shutdown	1	Selection	Edit	0	3	1	2	HF	HF
242	Gas: Valve proving - test space evacuating	1	Time	Edit	0,2 s	10 s	0,2 s	3 s	OEM	OEM
243	Gas: Valve proving - test time atmospheric pressure	1	Time	Edit	0,2 s	60 s	0,2 s	10 s	OEM	OEM
244	Gas: Valve proving - test space filling	1	Time	Edit	0,2 s	10 s	0,2 s	3 s	OEM	OEM
245	Gas: Valve proving - test time gas pressure	1	Time	Edit	0,2 s	60 s	0,2 s	10 s	OEM	OEM
246	Gas: Waiting time gas shortage	1	Time	Edit	0,2 s	60 s	0,2 s	10 s	OEM	OEM
248	Gas: Postpurge time (abortion with load controller-ON	1	Time	Edit	1 s	108 min	0,2 s	1 s	HF	HF
249	Gas: Prepurge time (OEM)	1	Time	Edit	5 s	60 min	0,2 s	20 s	OEM	HF
261	Oil: Active detector flame evaluation 0 = QRB / QRC 1 = ION / QRA	1	Selection	Edit	0	1	1	0	HF	HF
262	Oil: Prepurging 0 = inactive 1 = active	1	Selection	Edit	0	1	1	1	OEM	OEM
265	Oil: Prepurge time	1	Time	Edit	15 s	60 min	0,2 s	15 s	HF	HF
266	Oil: Preignition time	1	Time	Edit	0,6 s	60 min	0,2 s	2 s	HF	HF
267	Oil: First safety time	1	Time	Edit	1 s	15 s	0,2 s	5 s	OEM	OEM
269	Oil: Time to respond to pressure faults within first and second safety time	1	Time	Edit	0,4 s	14,6 s	0,2 s	1,8 s	OEM	OEM
270	Oil: Interval 1	1	Time	Edit	0,4 s	60 min	0,2 s	2 s	HF	HF
271	Oil: Second safety time	1	Time	Edit	1 s	15 s	0,2 s	5 s	OEM	OEM

Par. no.	Parameter	Number of elements	Type	Edit	Value range		Increment	Default setting		Password level	
					Min.	Max.		Write	Read		
272	Oil: Interval 2	1	Time	Edit	0,4 s	60 min	0,2 s	2 s		HF	HF
273	Oil: Afterburn time	1	Time	Edit	0,2 s	60 s	0,2 s	8 s		HF	HF
274	Oil: Postpurge time	1	Time	Edit	0,2 s	108 min	0,2 s	0,2 s		HF	HF
276	Oil: Input pressure switch-min 1 = active from phase 38 2 = active from safety time	1	Selection	Edit	1	2	1	1		HF	HF
277	Oil: Input pressure switch-max/POC 1 = pressure switch-max 2 = POC 3 = not used 4 = not used	1	Selection	Edit	1	4	1	1		HF	HF
280	Repetition limit value loss of flame 1 = no repetition 2 = 1 repetition Recharging time: After the <i>Operation</i> phase 1  Note! Parameters 280 and 240 refer to the same value. This means that no separate setting is possible for oil / gas or fuel 0 / fuel 1.	1	Std_u8	Edit	1	2	1	2		OEM	OEM
281	Oil: Point in time oil is ignited 0 = short preignition (phase 38) 1 = long preignition (with fan) (phase 22)	1	Selection	Edit	0	1	1	1		HF	HF
284	Oil: Postpurge time (abortion with load controller-ON)	1	Time	Edit	1 s	108 min	0,2 s	1 s		HF	HF
288	Oil: Prepurge time (OEM)	1	Time	Edit	5 s	60 min	0,2 s	15 s		OEM	HF
400	Ratio control curves										
401	Ratio control curve fuel actuator (only curve settings)	13	Std_s16	Edit	0°	90°	0,1°	0°; 0°; 15°; undefined		HF	HF
402	Ratio control curve air actuator (only curve settings)	13	Std_s16	Edit	0°	90°	0,1°	0°; 90°; 45°; undefined		HF	HF
500	Ratio control										
501	No-flame positions fuel actuator Index 0 = home position	3	Std_s16	Edit	0°	90°	0,1°	Index 0	Value 0°	HF	HF

Par. no.	Parameter	Number of elements	Type	Edit	Value range		Increment	Default setting		Password level	
					Min.	Max.		Write	Read		
	Index 1 = prepurge position Index 2 = postpurge position							1 2	0° 15°		
502	No-flame positions air actuator Index 0 = home position Index 1 = prepurge position Index 2 = postpurge position	3	Std_s16	Edit	0°	90°	0,1°	Index 0 1 2	Value 0° 90° 45°	HF	HF
544	Ramp modulating	1	Std_u8	Edit	32 s	80 s	1 s	32 s		HF	HF
545	Lower output limit undefined = 20 %	1	Output	Edit / clear	20%	100%	0,1%	undefined		HF	HF (GA)
546	Upper output limit undefined = 100 %	1	Output	Edit / clear	20%	100%	0,1%	undefined		HF	HF (GA)
600	Actuators										
601	Selection of reference point Index 0 = fuel Index 1 = air Setting values: 0 = CLOSED (<0°) 1 = OPEN (>90°)	2	Selection	Edit	0	1	1	Index 0 1	Value 1 0	OEM	HF
602	Actuator's direction of rotation Index 0 = fuel Index 1 = air Setting values: 0 = counterclockwise 1 = clockwise (exclusively for SQM3)	2	Selection	Edit	0	1	1	Index 0 1	Value 0 0	OEM	HF
606	Tolerance limit of position monitoring [0.1°] Index 0 = fuel Index 1 = air Greatest position error where a fault is securely detected → error detection band: (parameter 606-0.6°) to parameter 606	2	Std_u8	edit	0,5°	4°	0,1°	Index 0 1	Value 1,7° 1,7°	OEM	HF
611	Type of reference Index 0 = fuel Index 1 = air	2	Std_u8	Edit	0	3	1	Index 0 1	Value 0 0	OEM	HF

Par. no.	Parameter	Number of elements	Type	Edit	Value range		Increment	Default setting		Password level	
					Min.	Max.		Write	Read		
	Setting values: 0 = standard 1 = range stop in the usable range 2 = internal range stop (SQN1) 3 = both										
613	Type of actuator Index 0 = fuel Index 1 = air Setting values: 0 = 5 s / 90° (1 Nm, 1,2 Nm, 3 Nm) 1 = 10 s / 90° (6 Nm) 2 = 17 s / 90° (10 Nm)	2	Std_u8	Edit	0	2	1	0; 0		OEM	HF
645	Configuration of analog output 0 = DC 0...10 V 1 = DC 2...10 V 2 = DC 0/2...10 V	1	Std_u8	Edit	0	2	1	0		OEM	HF
700	Error history										
701	Current error state										
701.01	Error code	25	Std_u8	Read only	0	255	1	0		---	IS
701.02	Diagnostic code	25	Std_u8	Read only	0	255	1	0		---	IS
701.03	Error class	25	Std_u8	Read only	0	6	1	0		---	IS
701.04	Error phase	25	Std_u8	Read only	0	255	1	0		---	IS
701.05	Startup counter	25	Std_s32	Read only	0	99999999	1	0		---	IS
701.06	Output	25	Output	Read only	0%	100%	0,1%	0%		---	IS
702	Latest error in the history										
725	Oldest error in the history										
900	Process data										
903	Current output Index 0 = fuel Index 1 = air	2	Output	Read only	0%	100%	0,1%	0%		---	IS For query via ACS410
922	Incremental position of actuators Index 0 = fuel	2	Std_s16	Read only	-50°	150°	0,01°	0°		---	IS

Par. no.	Parameter	Number of elements	Type	Edit	Value range		Increment	Default setting	Password level	
					Min.	Max.			Write	Read
	Index 1 = air									
942	Active load controller source 1 = output during curve settings 2 = manual output 3 = default output via building automation 4 = default output via analog input 5 = external load controller via contacts	1	Selection	Read only	0	255	1	0	---	HF
947	Result of contact sensing (bit-coded) Bit 0.0 = 1: Pressure switch-min Bit 0.1 = 2: Pressure switch-max Bit 0.2 = 4: Pressure switch valve proving Bit 0.3 = 8: Air pressure switch Bit 0.4 = 16: Load controller OPEN Bit 0.5 = 32: Load controller ON Bit 0.6 = 64: Load controller CLOSE Bit 0.7 = 128: Safety loop Bit 1.0 = 1: Safety valve Bit 1.1 = 2: Ignition Bit 1.2 = 4: Fuel valve V1 Bit 1.3 = 8: Fuel valve V2 Bit 1.4 = 16: Fuel valve V3 / pilot valve Bit 1.5 = 32: Reset	2	Std_u8	Read only	0	255	1	0	---	IS For query via ACS410
948	Contact feedback network counter register	14	Std_u8	Read only	0	255	1	0	---	HF
950	Required relay state (bit-coded) Bit 0 = 1: Alarm Bit 1 = 2: Safety valve Bit 2 = 4: Ignition Bit 3 = 8: Fuel valve V1 Bit 4 = 16: Fuel valve V2 Bit 5 = 32: Fuel valve V3 / pilot valve	1	Std_u8	Read only	0	255	1	0	---	IS For query via ACS410
951	Mains voltage (normalized) AC 230 V: Voltage = value x 1.710 AC 120 V: Voltage = value x 0.866	1	Std_u8	Read only	0 V	255 V	1 V	0 V	---	HF (GA)
954	Intensity of flame	1	Std_u8	Read only	0%	100%	1%	0%	---	IS
960	Actual flow rate (m³/h, l/h, ft³/h, gal/h)	1	Std_u16	read only	0	6553,5	0,1	0	---	IS
961	Phase (state for external modules and display)	1	Std_u8	Read only	0	255	1	0	---	IS For query via

191/219

Par. no.	Parameter	Number of elements	Type	Edit	Value range		Increment	Default setting	Password level	
					Min.	Max.			Write	Read
										ACS410
981	Error memory: Code	1	Std_u8	read only	0	255	1	0	---	IS For query via ACS410
982	Error memory: Diagnostic code	1	Std_u8	read only	0	255	1	0	---	IS For query via ACS410
992	Error flags	10	Hex_32	Reset	0	0xFFFFFFFF	1	0	---	HF

Legend

Std_u8 8 Bit integer, not signed
Std_u16 16 Bit integer, not signed
Std_u32 32 Bit integer, not signed
Std_s8 8 Bit integer, signed



Note
This data type is also used to mark an invalid or signed values by using the value «-1».

Std_s16 16 Bit integer, signed



Note
This data type is also used to mark an invalid or signed values by using the value «-1».

Std_s32 32 Bit integer, signed





Note
This data type is also used to mark an invalid or signed values by using the value «-1».

28 Error code list (of all LMV2 / LMV3 types)

Error code	Diagnostic code	Meaning for the LMV27	Recommended measures or causes
no Comm		No communication between LMV27 and AZL2	Check wiring for open-circuit / loose contact
2	#	No flame at the end of first safety time	
	1	<i>No flame at the end of first safety time</i>	
	2	<i>No flame at the end of second safety time</i>	
	4	<i>No flame at the end of first safety time (software version ≤ V02.00)</i>	
3	#	Air pressure failure	
	0	<i>Air pressure off</i>	
	1	<i>Air pressure on</i>	
	2	<i>Evaluation of air pressure</i>	Correct the setting of parameter 235 or 335 (Deactivation of the air pressure check in operation only allowed in pneumatic operation!)
	4	<i>Air pressure on – start prevention</i>	
	20	<i>Air pressure, combustion pressure – start prevention</i>	
	68	<i>Air pressure, POC – start prevention</i>	
	84	<i>Air pressure, combustion pressure, POC – start prevention</i>	
4	#	Extraneous light	
	0	<i>Extraneous light during startup</i>	
	1	<i>Extraneous light during shutdown</i>	
	2	<i>Extraneous light during startup – start prevention</i>	
	6	<i>Extraneous light during startup, air pressure – start prevention</i>	
	18	<i>Extraneous light during startup, combustion pressure – start prevention</i>	
	24	<i>Extraneous light during startup, air pressure, combustion pressure – start prevention</i>	
	66	<i>Extraneous light during startup, POC – start prevention</i>	
	70	<i>Extraneous light during startup, air pressure, POC – start prevention</i>	
	82	<i>Extraneous light during startup, combustion pressure, POC – start prevention</i>	
	86	<i>Extraneous light during startup, air pressure, combustion pressure, POC – start prevention</i>	
7	#	Loss of flame	
	0	<i>Loss of flame</i>	
	3	<i>Loss of flame (software version ≤ V02.00)</i>	

Error code	Diagnostic code	Meaning for the LMV27	Recommended measures or causes
	3...255	<i>Loss of flame due to TÜV test (loss-of-flame test)</i>	Diagnostics corresponds to the period of time from shutdown of fuel valves to the detection of loss of flame (increment 0.2 seconds → value 5 = 1 second)
12	#	Valve proving	
	0	<i>Fuel valve V1 leaking (fuel valve V2 with valve proving via X5-01)</i>	With valve proving via X5-01 (gas pressure switch-min) - Check if valve on the burner side is leaking - Check if pressure switch for valve proving is closed, if gas pressure exist - Check wiring for short-circuit
	1	<i>Fuel valve V2 leaking (fuel valve V1 with valve proving via X5-01)</i>	With valve proving via X5-01 (gas pressure switch-min) - Check if valve on the gas side is leaking - Check wiring for short-circuit
	2	<i>Valve proving not possible</i>	Valve proving activated, but pressure switch-min selected as input function for X9-04 (check parameters 238 and 241)
	3	<i>Valve proving not possible</i>	Valve proving activated, but no input assigned (check parameters 236 and 237)
	4	<i>Valve proving not possible</i>	Valve proving activated, but 2 inputs assigned (set parameter 237 to pressure switch-max or POC)
	5	<i>Valve proving not possible</i>	Valve proving activated, but 2 inputs assigned (check parameters 236 and 237)
	81	<i>V1 leaking</i>	Check to see if the valve on the gas side is leaking Check wiring to see if there is an open-circuit
	83	<i>V2 leaking</i>	Check to see if the valve on the burner side is leaking Check to see if the pressure switch for the leakage test is closed when gas pressure is present Check wiring for short-circuit Check whether the gas pressure is present if the gas pressure switch-min was mounted after the fuel valves.
14	#	POC	
	0	<i>POC open</i>	Check to see if the valve's closing contact is closed
	1	<i>POC close</i>	Check wiring Check to see if the valve's closing contact opens when valve is controlled
	64	<i>POC open - start prevention</i>	Check wiring to see if there is a line interruption. Check to see if the valve's closing contact is closed
18	#	Air pressure fault (speed-dependent air pressure switch)	
	0	<i>Air pressure off</i>	Check the setting for parameter 671. Air pressure switch (X5-02) must report an ON signal above the configured ON threshold.
	1	<i>Air pressure on</i>	Check the setting for parameter 670. Air pressure switch (X5-02) must report an OFF signal below the configured OFF threshold.
	128	<i>Invalid parameterization</i>	Check the setting of the speed thresholds (parameter 671 > 670).
19	80	<i>Combustion pressure, POC – start prevention</i>	Check to see if pressure switch has closed with no combustion pressure present Check wiring for short-circuit
20	#	Pressure switch-min	
	0	<i>No minimum gas /oil pressure</i>	Check wiring for line interruption
	1	<i>Gas shortage – start prevention</i>	Check wiring for line interruption

Error code	Diagnostic code	Meaning for the LMV27	Recommended measures or causes
21	#	Pressure switch-max / POC	
	0	Pressure switch-max : Max. gas / oil pressure exceeded POC: POC open (software version ≤ V02.00)	Check wiring to see if there is a line interruption. POC: Check to see if the valve's closing contact is closed.
	1	POC close (software version ≤ V02.00)	Check wiring Check to see if the valve's closing contact opens when the valve is controlled
	64	POC open - start prevention (software version ≤ V02.00)	Check wiring Check to see if the valve's closing contact opens when the valve is controlled
22 OFF S	#	Safety loop / burner flange	
	0	Safety loop / burner flange open	
	1	Safety loop / burner flange open - start prevention	
	3	Safety loop/burner flange, extraneous light – start prevention	
	5	Safety loop/burner flange, air pressure – start prevention	
	17	Safety loop/burner flange, combustion pressure – start prevention	
	19	Safety loop/burner flange, extraneous light, combustion pressure – start prevention	
	21	Safety loop/burner flange, air pressure, combustion pressure – start prevention	
	23	Safety loop/burner flange, extraneous light, air pressure, combustion pressure – start prevention	
	65	Safety loop/burner flange, POC – start prevention	
	67	Safety loop/burner flange, extraneous light, POC – start prevention	
	69	Safety loop/burner flange, air pressure, POC – start prevention	
	71	Safety loop/burner flange, extraneous light, air pressure, POC – start prevention	
	81	Safety loop/burner flange, combustion pressure, POC – start prevention	
	83	Safety loop/burner flange, extraneous light, combustion pressure, POC – start prevention	
	85	Safety loop/burner flange, air pressure, combustion pressure, POC – start prevention	
	87	Safety loop/burner flange, extraneous light, air pressure, combustion pressure, POC – start prevention	
23	#	Gas pressure switch-min / heavy oil direct start	
	0	No minimum gas pressure	Check wiring to see if there is an open-circuit (X5-01)
	1	Gas shortage – start prevention	Check wiring to see if there is an open-circuit (X5-01)
	2	Heavy oil direct start	Check wiring to see if there is an open-circuit (X9-04)

Error code	Diagnostic code	Meaning for the LMV27	Recommended measures or causes
			Check that the oil is preheated correctly
50	#	Internal error	Make a reset; if error occurs repeatedly, replace the LMV27
51	#	Internal error	Make a reset; if error occurs repeatedly, replace the LMV27
55	#	Internal error	Make a reset; if error occurs repeatedly, replace the LMV27
56	#	Internal error	Make a reset; if error occurs repeatedly, replace the LMV27
57	#	Internal error	Make a reset; if error occurs repeatedly, replace the LMV27
58	#	Internal error	Make a reset; if error occurs repeatedly, replace the LMV27
60	#	Internal error: No valid load controller source	
	0	Internal error: No valid output source	Make a reset; if error occurs repeatedly, replace the LMV27
	1	Analog output preset valid – prevention of startup	1. Check wiring of analog predefined output to see if there is an open-circuit / loose contact. 2. When the trim function is activated (parameter 530), the default output must not be on invalid if the Modbus communication (parameter 148 / 149) is interrupted.
	2	Analog output preset valid – default output low-fire	1. Check wiring of analog predefined output to see if there is an open-circuit / loose contact. 2. When the trim function is activated (parameter 530), the default output must not be on invalid if the Modbus communication (parameter 148 / 149) is interrupted.
			 Note! This information is provided in connection with the thermal shock protection function (manual interruption of 4...20 mA analog input)
61 Fuel Chg	#	Fuel changeover	
Fuel Chg	0	Fuel 0	No error - change to Fuel 0
Fuel Chg	1	Fuel 1	No error - change to Fuel 1
62 Fuel Err	#	Invalid fuel signals / fuel information	
Fuel Err	0	Invalid fuel selection (Fuel 0 + 1 = 0)	Check wiring to see if there is an open-circuit
			 Note Curves cannot be set
Fuel Err	1	Different fuel selection between the μ Cs	Make a reset; if error occurs repeatedly, replace the LMV27
Fuel Err	2	Different fuel signals between the μ Cs	Make a reset; if error occurs repeatedly, replace the LMV27
Fuel Err	3	Invalid fuel selection (Fuel 0 + 1 = 1)	Check wiring for short-circuit
			 Note Curves cannot be set.

Error code	Diagnostic code	Meaning for the LMV27	Recommended measures or causes
			LMV27: Optional press reset button >3 seconds.
65	#	Internal error	Make a reset; if error occurs repeatedly, replace the LMV27
66	#	Internal error	Make a reset; if error occurs repeatedly, replace the LMV27
67	#	Internal error	Make a reset; if error occurs repeatedly, replace the LMV27
70	#	Internal error fuel / air ratio control: Position calculation modulating	
	23	<i>Output invalid</i>	No valid output
	26	<i>Curvepoints undefined</i>	Adjust the curvepoints for all actuators
71	#	Special position undefined	
	0	<i>Home position</i>	Parameterize the home position for all actuators used
	1	<i>Prepurge position</i>	Parameterize the prepurge position for all actuators used
	2	<i>Postpurge position</i>	Parameterize the postpurge position for all actuators used
	3	<i>Ignition position</i>	Parameterize the ignition position for all actuators used
72	#	Internal error fuel / air ratio control	Make a reset; if error occurs repeatedly, replace the LMV27
73	#	Internal error fuel / air ratio control: Position calculation stage	
	23	<i>Position calculation, multistep output invalid</i>	No valid output
	26	<i>Curvepoints undefined</i>	Adjust the curvepoints for all actuators
75	#	Internal error air-fuel ratio control: Data clocking check	
	1	<i>Current output different</i>	Check the external load controller, including the connection. Parameters 123.1 and 123.2 must be identical (example: set to 1).
	2	<i>Target output different</i>	Check the external load controller, including the connection. Parameters 123.1 and 123.2 must be identical (example: set to 1).
	4	<i>Target positions different</i>	Check the external load controller, including the connection. Parameters 123.1 and 123.2 must be identical (example: set to 1).
	6	<i>Target output and target position different</i>	Check the external load controller, including the connection. Parameters 123.1 and 123.2 must be identical (example: set to 1).
	16	<i>Different positions reached</i>	Can be caused by different standardized speeds (e.g. after restore of data set) when the VSD is activated → standardize again and check adjustment of the fuel-air ratio control system
76	#	Internal error fuel / air ratio control	Make a reset; if error occurs repeatedly, replace the LMV27
80	#	Control range limitation of VSD	LMV27 could not correct the difference in speed and reached a control range limit. 1. LMV27 is not standardized for this motor → repeat standardization.
			 Caution! Settings of fuel-air ratio control must be checked!
			2. Ramp time settings of the VSD are not shorter than those of the LMV27 (parameters 522, 523) or the setting for the modulating operating ramp is incorrect (parameter 544) 3. Characteristic of the VSD is not linear. Configuration of the voltage input at the VSD must accord with that of the LMV27 (parameter 645).

Error code	Diagnostic code	Meaning for the LMV27	Recommended measures or causes
			4. VSD does not follow quickly enough the changes of the LMV27. Check settings of the VSD (input filter, slippage compensation, hiding different speeds)
	1	Control range limitation at the bottom	VSD speed was too high
	2	Control range limitation at the top	VSD speed was too low
81	1	Interrupt limitation speed input	Too much electromagnetic interference on the sensor line → improve EMC
82	#	Error during VSD's speed standardization	
	1	Timeout of standardization (VSD ramp down time too long)	Timeout at the end of standardization during ramp down of the VSD → Ramp time settings of the VSD are not shorter than those of the LMV27 (parameter: 523)
	2	Storage of standardized speed not successful	Error during storage of the standardized speed → lock the LMV27, then reset it and repeat the standardization
	3	Line interruption speed sensor	LMV27 receives no pulses from the speed sensor: 1. Motor does not turn. 2. Speed sensor is not connected. 3. Speed sensor is not activated by the sensor disk (check distance)
	4	Speed variation / VSD ramp up time too long / speed below minimum limit for standardization	Motor has not reached a stable speed after ramp up. 1. Ramp time settings of the VSD are not shorter than those of the LMV27 (parameters 522, 523). 2. Characteristic of the VSD is not linear. Configuration of the voltage input at the VSD must accord with that of the LMV27 (parameter 645). 3. VSD does not follow quickly enough the changes of the LMV27. Check settings of the VSD (input filter, slippage compensation, hiding different speeds) 4. Speed of VSD lies below the minimum for standardization (650 1/min)
	5	Wrong direction of rotation	Motor's direction of rotation is wrong. 1. Motor turns indeed in the wrong direction → change parameterization of the direction of rotation or interchange 2 live conductors. 2. Sensor disk is fitted the wrong way → turn the sensor disk.
	6	Unplausible sensor signals	The required pulse pattern (60°, 120°, 180°) has not been correctly identified. 1. Speed sensor does not detect all tappets of the sensor disk → check distance 2. As the motor turns, other metal parts are detected also, in addition to the tappets → improve mounting. 3. Electromagnetic interference on the sensor lines → check cable routing, improve EMC 4. Checking the settings for parameters 643 (symmetry) and 644 (number of pulses per revolution)
	7	Invalid standardized speed	The standardized speed measured does not lie in the permissible range.

Error code	Diagnostic code	Meaning for the LMV27	Recommended measures or causes
			→ Motor turns too slowly or too fast.
15		Speed deviation $\mu C1 + \mu C2$	The speeds of microcomputer 1 and 2 deviated too much. This can be caused by wrong standardized speeds (e.g. after restoring a data set to a new LMV27) → repeat standardization and check the fuel-air ratio
20		Wrong phase of phase manager	Standardization was made in a wrong phase. Permitted are only phases ≤ 12 → load controller OFF, start standardization again
21		Safety loop / burner flange open	Safety loop or burner flange is open → repeat standardization with safety loop closed
22		Air actuator not referenced	Air actuator has not been referenced or has lost its referencing. 1. Check if the reference position can be approached. 2. Check if actuators have been mixed up. 3. If error only occurs after the start of standardization, the actuator might be overloaded and cannot reach its destination.
23		VSD deactivated	Standardization was started with VSD deactivated → activate the VSD and repeat standardization
24		No valid operation mode	Standardization was started without valid operation mode → activate valid operation mode and repeat standardization
25		Pneumatic air-fuel ratio control	Standardization was started with pneumatic air-fuel ratio control → standardization with pneumatic air-fuel ratio control not possible
			 Attention! If speed supervision is required in the pneumatic ratio control, the relevant parameters must be set (parameters 667 / 668 / 669) before standardization.
128		Running command with no preceding standardization	VSD is controlled but not standardized → make standardization
255		No standardized speed available	Motor turns but is not standardized → make standardization
83	#	Speed error VSD	Required speed has not been reached
	0	Speed error when trim function is active	Increase parameter 662 (neutral zone in speed supervision) and parameter 663 (close range in speed supervision)
	Bit 0 Valency 1	Lower control range limitation of control	Speed has not been reached because control range limitation has become active → for measures, refer to error code 80
	Bit 1 Valency 2...3	Upper control range limitation of control	Speed has not been reached because control range limitation has become active → for measures, refer to error code 80
	Bit 2 Valency 4...7	Interruption via disturbance pulses	Speed has not been reached due to too much electromagnetic interference on the sensor line → for measures, refer to error code 81
	Bit 3 Valency ≥ 8	Curve too steep in terms of ramp speed	Check speed differential between the curvepoints and the modulating operating ramp setting (parameter 544). 1. Modulating operating ramp 32 seconds

Error code	Diagnostic code	Meaning for the LMV27	Recommended measures or causes
			<p>Curve slope max. 10% for LMV27 ramp of 20 seconds (20% for 10 seconds or 40% for 5 seconds)</p> <p>2. Modulating operating ramp 48 seconds</p> <p>Curve slope max. 10% for LMV27 ramp of 30 seconds (20% for 15 seconds or 30% for 10 seconds)</p> <p>3. Modulating operating ramp 64 seconds</p> <p>Curve slope max. 10% for LMV27 ramp of 40 seconds (20% for 20 seconds or 40% for 10 seconds)</p> <p>→ Between the ignition point (P0) and the low-fire point (P1), the speed change in modulating mode may be a maximum of 40%, independent of the LMV27 ramp.</p> <p>4. The setting of the VSD ramp must be about 20% faster than the ramps in the LMV27 (parameters 522, 523).</p>
	<p><i>Bit 4</i> Valency ≥ 16</p>	<i>Interruption of speed signal</i>	<p>No speed detected in spite of control.</p> <ol style="list-style-type: none"> 1. Check if the motor turns. 2. Check if the speed sensor delivers a signal (LED / check distance from the sensor disk). 3. Check wiring of the VSD.
	<p><i>Bit 5</i> Valency ≥ 32</p>	<i>Quick shutdown due to excessive speed deviation</i>	<p>Speed deviation was for about 1 s >10% outside the anticipated range.</p> <ol style="list-style-type: none"> 1. Check ramp times of the LMV27 and VSD. 2. Check wiring of the VSD.
	<p><i>Bit 6</i> Valency ≥ 64</p>	<i>Minimum speed fall below (phase-dependent)</i>	<ol style="list-style-type: none"> 1. Standby (phase 12): Check the setting for the minimum speed and maximum speed during operation (parameter 669.0 / 669.1; MAX > MIN). 2. Check the speed recording (absolute speed parameter 935, standardized speed parameter 936). 3. Prepurge phase (phase 30): Read-in speed or prepurge speed (parameter 503.1 / 506.1) below the minimum speed for prepurging (parameter 667). 4. Operating phases (phase 40...64): Read-in speed or setting of the speed curve below the minimum speed in operation (parameter 669.0).
	<p><i>Bit 7</i> Valency ≥ 128</p>	<i>Maximum speed exceeded (phase-dependent)</i>	<ol style="list-style-type: none"> 1. Standby (phase 12): Setting preignition time (parameter gas 226 / 336 or oil 266 / 366) at least 3 seconds (or \geq parameter 665) 2. Standby (phase 12): Check the setting for the minimum speed and maximum speed during operation (parameter 669.0 / 669.1; MAX > MIN). 3. Check the speed recording (absolute speed parameter 935, standardized speed parameter 936). 4. Preignition time (phase 38): Read-in speed or setting of the ignition speed (P0) above the maximum speed for ignition (parameter 668). 5. Operating phases (phase 40...64): Read-in speed or setting of the speed curve above the maximum speed in operation (parameter 669.1).
84	#	Curve slope actuators	

Error code	Diagnostic code	Meaning for the LMV27	Recommended measures or causes
	Bit 0 Valency 1	VSD: Curve too steep in terms of ramp speed	<p>Check speed differential between the curvepoints and the modulating operating ramp setting (parameter 544).</p> <ol style="list-style-type: none"> 1. Modulating operating ramp 32 seconds Curve slope max. 10% for LMV27 ramp of 20 seconds (20% for 10 seconds or 40% for 5 seconds) 2. Modulating operating ramp 48 seconds Curve slope max. 10% for LMV27 ramp of 30 seconds (20% for 15 seconds or 30% for 10 seconds) 3. Modulating operating ramp 64 seconds Curve slope max. 10% for LMV27 ramp of 40 seconds (20% for 20 seconds or 40% for 10 seconds) <p>→ Between the ignition point (P0) and the low-fire point (P1), the speed change in modulating mode may be a maximum of 40%, independent of the LMV27 ramp.</p> <ol style="list-style-type: none"> 4. Setting of the VSD ramp must be about 20% shorter than the ramps in the LMV27 (parameters 522 and 523)
	Bit 1 Valency 2..3	Fuel actuator: Curve too steep in terms of ramp rate	<p>Check position differential between the curvepoints and the modulating operating ramp setting (parameter 544).</p> <ol style="list-style-type: none"> 1. Modulating operating ramp 32 seconds The slope of the curve may be a maximum position change of 31° (15° for SQM33.6 and 9° for SQM33.7) between 2 curve points in modulating mode. 2. Modulating operating ramp 64 seconds The slope of the curve may be a maximum position change of 62° (30° for SQM33.6 and 18° for SQM33.7) between 2 curve points in modulating mode.
	Bit 2 Valency 4..7	Air actuator: Curve too steep in terms of ramp rate	<p>Check position differential between the curvepoints and the modulating operating ramp setting (parameter 544).</p> <ol style="list-style-type: none"> 1. Modulating operating ramp 32 seconds The slope of the curve may be a maximum position change of 31° (15° for SQM33.6 and 9° for SQM33.7) between 2 curve points in modulating mode. 2. Modulating operating ramp 64 seconds The slope of the curve may be a maximum position change of 62° (30° for SQM33.6 and 18° for SQM33.7) between 2 curve points in modulating mode.
85	#	Referencing error ones actuators	
	0	Referencing error of fuel actuator	<p>Referencing of fuel actuator not successful. Reference point could not be reached.</p> <ol style="list-style-type: none"> 1. Check the setting of the actuator type (parameter 613.0 or 614) 2. Check to see if actuators have been mixed up. 3. Check to see if actuator is locked or overloaded.
	1	Referencing error of air actuator	<p>Referencing of air actuator not successful Reference point could not be reached.</p>

Error code	Diagnostic code	Meaning for the LMV27	Recommended measures or causes
			<ol style="list-style-type: none"> 1. Check the setting of the actuator type (parameter 613.1) 2. Check to see if actuators have been mixed up 3. Check to see if actuator is locked or overloaded
	Bit 7 Valency ≥ 128	Referencing error due to parameter change	Parameterization of an actuator (e.g. the reference position) has been changed. To trigger new referencing, this error will be set
86	#	Error fuel actuator	
	0	Position error	Target position could not be reached within the required tolerance band. → Check to see if the actuator is locked or overloaded.
	Bit 0 Valency 1	Line interruption	Line interruption detected at actuator's terminals. → Check wiring (voltage X54 across pin 5 or 6 and pin 2 >0.5 V).
	Bit 3 Valency ≥ 8	Curve too steep in terms of ramp rate	<p>Check position differential between the curvepoints and the modulating operating ramp setting (parameter 544).</p> <ol style="list-style-type: none"> 1. Modulating operating ramp 32 seconds The slope of the curve may be a maximum position change of 31° (15° for SQM33.6 and 9° for SQM33.7) between 2 curve points in modulating mode. 2. Modulating operating ramp 64 seconds The slope of the curve may be a maximum position change of 62° (30° for SQM33.6 and 18° for SQM33.7) between 2 curve points in modulating mode.
	Bit 4 Valency ≥ 16	Step deviation in comparison with last referencing	<p>Actuator was overloaded or mechanically twisted.</p> <ol style="list-style-type: none"> 1. Check the setting of the actuator type (parameter 613.0 or 614) 2. Check to see if the actuator is blocked somewhere along its working range. 3. Check to see if the torque is sufficient for the application.
87	#	Error air actuator	
	0	Position error	Target position could not be reached within the required tolerance band. → Check to see if the actuator is locked or overloaded.
	Bit 0 Valency 1	Line interruption	Line interruption detected at actuator's terminals. → Check wiring (voltage X53 across pin 5 or 6 and pin 2 >0.5 V).
	Bit 3 Valency ≥ 8	Curve too steep in terms of ramp rate	<p>Check position differential between the curvepoints and the modulating operating ramp setting (parameter 544).</p> <ol style="list-style-type: none"> 1. Modulating operating ramp 32 seconds The slope of the curve may be a maximum position change of 31° (15° for SQM33.6 and 9° for SQM33.7) between 2 curve points in modulating mode. 2. Modulating operating ramp 64 seconds The slope of the curve may be a maximum position change of 62° (30° for SQM33.6 and 18° for SQM33.7) between 2 curve points in modulating mode.
	Bit 4 Valency ≥ 16	Sectional deviation in comparison with last referencing	<p>Actuator was overloaded or mechanically twisted.</p> <ol style="list-style-type: none"> 1. Check the setting of the actuator type (parameter 613.1) 2. Check to see if the actuator is blocked somewhere along its working range. 3. Check to see if the torque is sufficient for the application.
90	#	Internal error LMV27	

202/219

Error code	Diagnostic code	Meaning for the LMV27	Recommended measures or causes
91	#	Internal error LMV27	
93	#	Error flame signal acquisition	
	3	<i>Short-circuit of sensor</i>	<i>Short-circuit at QRB</i> 1. Check wiring. 2. Flame detector possibly faulty.
95	#	Error relay supervision	
	3 Ignition transformer 4 Fuel valve V1 5 Fuel valve V2 6 Fuel valve V3	<i>External power supply active contact</i>	Check wiring
96	#	Error relay supervision	
	3 Ignition transformer 4 Fuel valve V1 5 Fuel valve V2 6 Fuel valve V3	<i>Relay contacts have welded</i>	Test the contacts: 1. LMV27 connected to power: Fan output must be dead. 2. Disconnect power: Disconnect fan. No resistive connection between fan output and neutral conductor allowed. If one of the 2 tests fails, release the LMV27 since contact have definitively welded and safety can no longer be ensured.
97	#	Error relay supervision	
	0	<i>Safety relay contacts have welded or external power supply fed to safety relay</i>	Test the contacts: 1. LMV27 connected to power: Fan output must be dead. 2. Disconnect power: Disconnect fan. No resistive connection between fan output and neutral conductor allowed. If one of the 2 tests fails, release the LMV27 since contacts have definitively welded and safety can no longer be ensured.
98	#	Error relay supervision	
	2 Safety valve 3 Ignition transformer 4 Fuel valve V1 5 Fuel valve V2 6 Fuel valve V3	<i>Relay does not pull in</i>	Make a reset; if error occurs repeatedly, replace the LMV27
99	#	Internal error relay control	Make a reset; if error occurs repeatedly, replace the LMV27
	3	<i>Internal error relay control</i>	Make a reset. If error occurs repeatedly, replace the LMV27 Software version V03.10: If error C:99 D:3 occurs during standardization of the VSD, deactivate temporarily function <i>Alarm in case of start prevention</i> (parameter 210 = 0, when using a release contact) or <i>interrupt</i> the load controller-ON signal
100	#	Internal error relay control	Make a reset; if error occurs repeatedly, replace the LMV27
105	#	Internal error contact sampling	
	0 Pressure switch min	<i>Stuck-At failure</i>	Can be caused by capacitive loads or supply of DC voltage to the mains voltage inputs. The

Error code	Diagnostic code	Meaning for the LMV27	Recommended measures or causes
	<ul style="list-style-type: none"> 1 Pressure switch max / POC 2 Pressure switch valve proving 3 Air pressure 4 Load controller open 5 Load controller on/off 6 Load controller close 7 Safety loop / Burner flange 8 Safety valve 9 Ignition transformer 10 Fuel valve V1 11 Fuel valve V2 12 Fuel valve V3 13 Reset 		diagnostic code indicates the input where the problem occurred
106	#	Internal error contact request	Make a reset; if error occurs repeatedly, replace the LMV27
	<ul style="list-style-type: none"> 0 Pressure switch min 1 Pressure switch max / POC 2 Pressure switch valve proving 3 Air pressure 4 Load controller open 5 Load controller on/off 6 Load controller close 7 Safety loop / Burner flange 8 Safety valve 9 Ignition transformer 10 Fuel valve V1 11 Fuel valve V2 12 Fuel valve V3 13 Reset 		
107	#	Internal error contact request	Make a reset; if error occurs repeatedly, replace the LMV27
	<ul style="list-style-type: none"> 0 Pressure switch min 1 Pressure switch max / POC 2 Pressure switch valve proving 3 Air pressure 4 Load controller open 5 Load controller on/off 6 Load controller close 7 Safety loop / Burner flange 8 Safety valve 		

Error code	Diagnostic code	Meaning for the LMV27	Recommended measures or causes
	9 Ignition transformer 10 Fuel valve V1 11 Fuel valve V2 12 Fuel valve V3 13 Reset		
108	#	Internal error contact request	Make a reset; if error occurs repeatedly, replace the LMV27
	0 Pressure switch min 1 Pressure switch max / POC 2 Pressure switch valve proving 3 Air pressure 4 Load controller open 5 Load controller on/off 6 Load controller close 7 Safety loop / Burner flange 8 Safety valve 9 Ignition transformer 10 Fuel valve V1 11 Fuel valve V2 12 Fuel valve V3 13 Reset		
110	#	Internal error voltage monitor test	Make a reset; if error occurs repeatedly, replace the LMV27
111	#	Mains undervoltage	Mains voltage to low Conversion factor diagnostic code → voltage value (120 V: 0.843 / 230 V: 1,683)
112	0	Mains voltage recovery	Error code for triggering a reset on power restoration (no error)
113	#	Internal error mains voltage supervision	Make a reset; if error occurs repeatedly, replace the LMV27
115	#	Internal error system counter	
116	0	Designed lifecycle exceeded (250,000 startups)	Warning threshold has been reached. The LMV27 should be replaced
117	0	Life time exceeded Operation no longer allowed	Switch-off threshold has been reached
120	0	Interrupt limitation fuel counter input	Too many disturbance pulses at the fuel meters input → Improve EMC
121	#	Internal error EEPROM access	Make a reset, repeat last parameterization / check. Restore the parameter set, if error occurs repeatedly, replace the LMV27
122	#	Internal error EEPROM access	Make a reset, repeat last parameterization / check. Restore the parameter set, if error occurs repeatedly, replace the LMV27
123	#	Internal error EEPROM access	Make a reset, repeat last parameterization / check. Restore the parameter set, if error occurs repeatedly, replace the LMV27

Error code	Diagnostic code	Meaning for the LMV27	Recommended measures or causes
124	#	Internal error EEPROM access	Make a reset, repeat last parameterization / check. Restore the parameter set, if error occurs repeatedly, replace the LMV27
125	#	Internal error EEPROM read access	Make a reset, repeat last parameterization / check. If error occurs repeatedly, replace the LMV27
126	#	Internal error EEPROM write access	Make a reset, repeat last parameterization / check. If error occurs repeatedly, replace the LMV27
127	#	Internal error EEPROM access	Make a reset, repeat last parameterization / check. Restore the parameter set, if error occurs repeatedly, replace the LMV27
128	0	<i>Internal error EEPROM access - synchronization during initialization</i>	Make a reset; if error occurs repeatedly, replace the LMV27
129	#	Internal error EEPROM access – command synchronization	Make a reset, repeat last parameterization / check. If error occurs repeatedly, replace the LMV27
130	#	Internal error EEPROM access - timeout	Make a reset, repeat last parameterization / check. If error occurs repeatedly, replace the LMV27
131	#	Internal error EEPROM access - page on abort	Make a reset, repeat last parameterization / check. If error occurs repeatedly, replace the LMV27
132	#	Internal error EEPROM register initialization	Make a reset; if error occurs repeatedly, replace the LMV27
133	#	Internal error EEPROM access – Request synchronization	Make a reset, repeat last parameterization / check. If error occurs repeatedly, replace the LMV27
134	#	Internal error EEPROM access – Request synchronization	Make a reset, repeat last parameterization / check. If error occurs repeatedly, replace the LMV27
135	#	Internal error EEPROM access – Request synchronization	Make a reset, repeat last parameterization / check. If error occurs repeatedly, replace the LMV27
136	#	Restore	
	1	<i>Restore started</i>	Restore of a backup has been started (no error) New LMV27 require resetting following restore!
		for further diagnostic codes for error code 136, refer to error code 137	For measures, refer to error code 137
137	#	Internal error – backup / restore	
	157 (-99)	<i>Restore – ok, but backup < data set of current LMV27</i>	Restore successful, but backup data set is smaller than in the current LMV27
	239 (-17)	<i>Backup – storage of backup in AZL2 faulty</i>	Make reset and repeat backup
	240 (-16)	<i>Restore – no backup in AZL2</i>	No backup in AZL2
	241 (-15)	<i>Restore – abortion due to unsuitable product no. (ASN)</i>	Backup has an unsuitable product no. (ASN) and must not be loaded on the LMV27
	242 (-14)	<i>Backup – backup made is inconsistent</i>	Backup is faulty and cannot be transferred back
	243 (-13)	<i>Backup – data comparison between µCs faulty</i>	Reset and repeat backup
	244 (-12)	<i>Backup data are incompatible</i>	Backup data are incompatible with the current software version, restore not possible
	245 (-11)	<i>Access error to parameter Restore_Complete</i>	Repeat reset and backup
	246 (-10)	<i>Restore – timeout when storing in EEPROM</i>	Repeat reset and backup
	247 (-9)	<i>Data received are inconsistent</i>	Backup data set invalid, restore not possible
	248 (-8)	<i>Restore cannot at present be made</i>	Repeat reset and backup
	249 (-7)	<i>Restore – abortion due to unsuitable burner identification</i>	Backup has an unsuitable burner identification and must not be transferred to the LMV27
	250 (-6)	<i>Backup – CRC of one page is not correct</i>	Backup data set invalid, restore not possible

Error code	Diagnostic code	Meaning for the LMV27	Recommended measures or causes
	251 (-5)	Backup – burner identification is not defined	Define burner identification and repeat backup
	252 (-4)	After restore, pages still on ABORT	Repeat reset and backup
	253 (-3)	Restore cannot at present be made	Repeat reset and backup
	254 (-2)	Abortion due to transmission error	Repeat reset and backup
	255 (-1)	Abortion due to timeout during restore	Make a reset, check the connections and repeat the backup
146	#	Timeout building automation interface	Refer to User Documentation Modbus (A7541)
	1	Modbus timeout	
	2	eBus timeout	
150	#	TÜV test	
	1 (-1)	Invalid phase	TÜV test may only be started in phase 60 (operation)
	2 (-2)	TÜV test default output too low	TÜV test default output must be lower than the lower output limit
	3 (-3)	TÜV test default output too high	TÜV test default output must be higher than the upper output limit
	4 (-4)	Manual abortion	No error: Manual abortion of TÜV test by the user
	5 (-5)	TÜV test timeout	No loss of flame after fuel valves have been shut 1. Check for extraneous light 2. Check wiring for short-circuit 3. Check to see if one of the valves is leaking
154	#	Trim function: Invalid analog value	1. Check wiring of analog trim specification to see if there is an open-circuit / loose contact 2. Check the process date of the read-in trim specification (parameter 916; 4 mA = -15% / 12 mA = 0% / 20 mA = 15%)
	1	Start prevention	
	2	Warning message (trim function temporarily deactivated)	
155	#	Trim function: Invalid curve setting VSD / PWM fan	The curve setting of the VSD / PWM fan must include a reserve for the set trim range. ((Minimum value curve + negative trim range) ≤ curve point ≤ (maximum value curve - positive trim range))
	1..9	Minimum value VSD curve fall below	The curvepoint of the VSD curve is below the permissible minimum value (diagnostic code = curvepoint number; e.g. 1 = P1)
	21..29	Maximum value VSD curve exceeded	The curvepoint of the VSD curve is above the permissible maximum value (diagnostic code = curvepoint number; e.g. 21 = P1)
	41..49	Fuel 1: Minimum value VSD curve fall below	Fuel 1: The curvepoint of the VSD curve is below the permissible minimum value (diagnostic code = curvepoint number; e.g. 41 = P1)
	61..69	Fuel 1: Maximum value VSD curve exceeded	Fuel 1: The curvepoint of the VSD curve is above the permissible maximum value (diagnostic code = curvepoint number; e.g. 61 = P1)
156	#	Trim function: Maximum time for range limit exceeded	 Warning message! Trim function is in limitation for too long (parameter 535; 916 < 531 or 916 > 532).This can be an indication that the trim function or the VSD curve is set

Error code	Diagnostic code	Meaning for the LMV27	Recommended measures or causes
			incorrectly.
	0	Trim function at lower limit	
	1	Trim function at upper limit	
	10	Fuel 1: Trim function at lower limit	
	11	Fuel 1: Trim function at upper limit	
157	#	Trim function: Analog input test	Test value of the analog input is outside the tolerance range
	0	Analog value standby	1. Check whether a current setting of 12 mA is present in standby. 2. Check parameter 916 (permissible value range -1...+1%).
	1	Analog value prepurging	1. Check whether a current setting of 4 mA is present in prepurging. 2. Check parameter 916 (permissible value range -16...-14%).
165	#	Internal error	
166	0	Internal error watchdog reset	
167	#	Manual locking	LMV27 has been manually locked (no error)
	1	Manual locking by contact	
	2	Manual locking by AZL2	
	3	Manual locking by ACS410 PC software	
	8	Manual locking by the AZL2 Timeout / communication breakdown	During a curve setting via the AZL2, the timeout for menu operation has elapsed (setting via parameter 127), or communication between the LMV27 and the AZL2 has broken down
	9	Manual locking by the ACS410 PC software Communication breakdown	During a curve setting via the ACS410, communication between the LMV27 and the ACS410 was interrupted for more than 30 seconds
	33	Manual locking after ACS410 PC software reset attempt	ACS410 PC software made a reset attempt although the system worked correctly
168	#	Internal error management	Make a reset; if error occurs repeatedly, replace the LMV27
169	#	Internal error management	Make a reset; if error occurs repeatedly, replace the LMV27
170	#	Internal error management	Make a reset; if error occurs repeatedly, replace the LMV27
171	#	Internal error management	Make a reset; if error occurs repeatedly, replace the LMV27
200 OFF	#	LMV27 error-free	No error
201 OFF UPr	#	Start prevention	Start prevention due to unparameterized LMV27 Go to error history, entry 702, for initial cause of the error with shutdown in connection with the first curve settings
	Bit 0 Valency 1	No operating mode selected	
	Bit 1 Valency 2..3	No fuel train defined	
	Bit 2 Valency 4..7	No curves defined	

Error code	Diagnostic code	Meaning for the LMV27	Recommended measures or causes
	Bit 3 Valency 8..15	Standardized speed undefined	Carry out speed standardization. If no speed signal is present in pneumatic operation, the parameters 667, 668, 669.0 / 669.1 must be set to <i>invalid</i> to switch off the start prevention.
	Bit 4 Valency 16..31	Backup / restore was not possible	
202	#	Internal error operating mode selection	Redefine the operating mode (parameter 201)
203	#	Internal error	Redefine the operating mode (parameter 201). Make a reset; if error occurs repeatedly, replace the LMV27
204	Phase number	Program stop	Program stop is active (no error)
205	#	Internal error	Make a reset; if error occurs repeatedly, replace the LMV27
206	0	Inadmissible combination of LMV27 (LMV27 - AZL2)	
207	#	Version compatibility LMV27 - AZL2	
	0	LMV27 version too old	
	1	AZL2 version too old	
208	#	Internal error	Make a reset; if error occurs repeatedly, replace the LMV27
209	#	Internal error	Make a reset; if error occurs repeatedly, replace the LMV27
210	0	Selected operating mode is not released for the LMV27	Select a released operating mode for the LMV27
240	#	Internal error	Make a reset; if error occurs repeatedly, replace the LMV27
242	#	Invalid parameterization	
	0	Invalid setting parameter 277	Set parameter 277 to a valid value
	1	Invalid setting parameter 377	Set parameter 377 to a valid value
245	#	Internal error	Make a reset; if error occurs repeatedly, replace the LMV27
250	#	Internal error	Make a reset; if error occurs repeatedly, replace the LMV27

29 Revision history LMV27

Software changes

Software version V01.20

- Optimizations regarding ACS410 (backup / restore)
- Faster parameterization with AZL2 (3-stage)
- Burner identification setting (entering the password)
- Optimization: LMV27 hooks itself up in phase 38
- Optimization: Cold setting via P0 (adoption P0 → P1, correct CALC function)
- Optimization: Delete history (acknowledgement upon completion)
- Prepurging oil – activated / deactivated (parameter 262) for OEM level released
- Setting range of pulse valency fuel meter (parameter 128) increased to 400 pulses per volume unit
- New parameter 645 = configuration analog output

Software version V01.30

- Optimization of phase manager (rectification of error 107)
- Presetting of parameter 281 (time oil ignition) changed to long preignition (with fan)

Software version V01.40

- Optimization: Modbus mode and operating mode are maintained when a reset is made
- Extension: Additional Modbus addresses (refer to Modbus Documentation A7541)
- Extension: Actuator tolerance can be parameterized by OEM and read by the heating engineer
- Change: The heating engineer can set the time when valve proving takes place
- Extension: Calculation of fuel throughput
- Optimization: Separate diagnostic code in the event standardization has not been successful due to an undefined operating mode
- Optimization: Change of password without having to enter the currently valid password
- Extension: Restore of data set possible only when type references of LMV27 and data set are identical
- Optimization: Alarm in the event of start prevention after a fixed time of 5 seconds
- Extension: Selection of POC function or Pmax

Software version V01.80

- Change: Combined valve proving via Pmin deactivated
- Optimization: Valve proving during shutdown after display error in operation
- Optimization: Any valve proving aborted by Pmin during shutdown will be repeated with the next startup

Software version V01.90

- Scaling of analog input changed (no *burner OFF* functionality)
- Optimization: Variable step width between ignition and low-fire (40% difference in speed, independent of ramp time; traveling time varies between 4 and 16 seconds with a 5- to 20-second ramp)
- Optimization: Checking the standardized speed between microcomputer 1 and microcomputer 2 (wrong standardized speeds after restore)
Objective: Avoiding wrong standardized speeds after restore to new hardware resulting from resonator tolerances of the 2 microcomputers
- Optimization: Parameter access when firing on oil
- Optimization: Assessment of *Pmin* in phase 62

Software version V2.00

- Correction to fuel train Gp1: First safety time was up to 0.4 seconds too long
- Correction to fuel train Gp1: Evaluation of pressure switches in phases 40 to 50 (*Pmin* / *Pmax* were not valued in phase 44, *Pmin* / *Pmax* were evaluated in phase 50 although the main valve was switched on)
- First error reception for gas shortage with first setting (gas shortage error was exceeded with first setting of *OFF UPr* – both errors occur in the same cycle)
- Timeout (parameter 127) or communication breakdown with the AZL2 leads to lockout during the time the curves are set (error code: 167, diagnostics: 8)
→ with cold setting, no startup on completion of the password time
- Communication breakdown with the ACS410 (30 seconds) leads to lockout during the time the curves are set (error code: 167, diagnostics 9)

Software version V02.90

- Optimization: Indication of errors on the parameter and info / service menu
- Optimization: Rectification of eBus error telegrams, correction of manufacturer's code for safety temperature limiter, extension of service data query PB:03h SB:10h in order to read out / query the meter readings for the second fuel; the current fuel is output in query PB:05h SB:09h
- Optimization: Curve setting invalid (*OFF UPr*) upon change to cold settings
- Optimization: Setting of minimum / maximum output via the parameterized output
- Optimization: Shorter startup time with valve proving (prepurge or postpurge time simultaneously with valve proving)
- New function: Loss-of-flame test (TÜV test), forced shutdown of fuel valves
- Extension: Oil pressure switch-min active from phase 38 or safety time (phase 40)
Extension: Setting of dead band zone for load controller contacts, analog input and BACS output
- Extension: POC for firing on oil (alternative to pressure switch-max)
- New function: Valve proving via pressure switch-min
- New function: Abortion of postpurging (see postpurge time, extraneous light test in phase 78)
- New function: Evaluation of load controller contacts for multistage operation (normal / interchanged)
- New fuel trains LoGp, Lo-2V, LoGp-2V
- New operating modes (e.g. without actuator)
- New function: Backup / restore via AZL2 (only with new software version AZL2)

Software version V03.00

- Optimization: Maximum time of safety phase reduced from 28 to 27 seconds

Software version V03.10

- Optimization: If power supply fails during the restore process, the data set can be repaired by starting a new restore process (since the backup / restore option is not yet available with V03.00 because there is no suitable AZL2, this effect cannot occur)
- Optimization: When making a reset via the AZL2, an *incomplete* reset occurred in very rare cases (display showed *RESEt*, but reset was not triggered)
- Optimization: The time ascertained by the loss-of-flame test was 0.2 seconds too long
- Optimization: Reduced detection of undervoltage when fan motor is started in phase 22 (when a single-phase motor and the LMV27 were powered via the same phase, undervoltage detection could occur on startup; in that case, the LMV27 was not operated as specified)
- Optimization: Better overview through text changes of groups 200 = PAr0, 300 = PAr1 and 600 = ACtr on the parameter menu (initially PArA), and hiding of unused parameters after selection of fuel train / operating mode
- Optimization: To shorten the startup time, there is no referencing when postpurging is aborted via load controller-ON (direct start)
- Automatic return travel of the SQN1 at the lower internal stop

Software version V03.30

- Extension: Display of intensity of flame when setting the curves
- Optimization: Display and diagnostics of changing start preventions
- Optimization: No unplausible relay setpoint (error C:99 D:3) when starting standardization, alarm in case of start prevention and load controller-ON signal
- Optimization: Referencing in connection with direction of rotation *Right* and home position 90°

Software version V03.40

- Extension: Supports SQM33.6 or SQM33.7
- Extension: Postpurging in the lockout position
- Extension: *No flame at the end of safety time* TSA repetition counter, adjustable *air pressure failure* (OEM), heavy oil direct start (SO)
- Extension: Air pressure supervision in operation with pneumatic ratio control can be switched off (OEM)
- Extension: Modbus data points
127 = Fuel 0 operating mode (parameter 201)

Software version V03.70

- Optimization: No locking with C:75 via asynchronous load controller source
- Extension: Support of PWM fans and symmetrical feedback
- Extension: Increase in the maximum speed to 14000 rpm
- Extension: Additional monitoring of the minimum prepurge speed, maximum ignition speed and minimum speed / maximum speed during operation
- Extension: Increased flexibility when setting the curve (gradient VSD curve)
- Extension: Operating modes for G / Gp2 with mechanical ratio control (air actuator only)
- Extension: Trim function for e.g. O2 or temperature
- Extension: Separate phase for running the fan to ignition speed, postpurge speed or standby speed, as well as increased speed tolerance outside operation
- Extension: Speed-dependent air pressure switch
- Extension: Increase in the flame sensitivity
- Extension: Gas pressure switch-min positioned after the fuel valves (CSA 149.3)
- Extension: Immediate lockout in the event of inadequate air supply (UL 795 / EN 676)
- Optimization: No repetition during successive error messages
- Extension: At the end of the speed standardization, the speed must be <10%
- Extension: Modbus data points
 - 140 = fuel 0 operating mode (parameter 201)
 - 142 = meter for function *Revert to Pilot*
 - 144 = lower range limit trim function
 - 145 = upper range limit trim function
 - 146 = lower range limit trim function fuel 1
 - 147 = upper range limit trim function fuel 1
 - 148 = input value analog input trim function
 - 149 = current trim impact
 - 150 = absolute speed
 - 151 = standardized mains voltage (conversion required)

Index

A

ACS410.....	114
Display / diagnostics.....	33
Actuators X53 / X54.....	98
Angles.....	98
Direction of rotation.....	103
Error detection band.....	105
Forced travel.....	105
Function principle.....	98
Implementations.....	106
Line interruptions.....	105
Mixup.....	106
Position.....	104
Referencing.....	99
AGV50	
Technical data.....	25
AZL2	
Backup.....	123
Backup / restore.....	122
Brightness.....	119
Burner identification.....	135
Burner identification entry.....	143
Curvepoint editing.....	170
Curvepoint interpolation.....	171
Description.....	118
Display / diagnostics.....	33
Error / safety shutdown.....	131
Error history.....	139
Errors.....	130
Fault numbers.....	139
Faults / errors / info.....	130
Flame intensity.....	139, 180
Fuel-air ratio curves.....	158
G mod / Gp1 mod / Gp2 mod / Lo mod.....	161, 163, 168
G mod pneu / Gp1 mod pneu / Gp2 mod pneu.....	162, 168, 169
General information.....	131
Identification date.....	134
Identification number.....	134
Info / lockout.....	130
Info level.....	133
Info level end.....	137
Info values.....	134
Initial commissioning.....	158
Levels.....	132
List phase displays.....	128
Lo 2-stage / Lo 3 stage.....	175, 179
Lo 2-stage / Lo 3-stage.....	174
Manual control.....	121
Manual lockout.....	120
Menu-driven operation.....	132
Normal display.....	127
Operating.....	118
Operating position.....	129

Operation.....	127
Parameter level.....	140
Parameter level structure.....	148
Parameter level use.....	147
Parameter with index / with direct display.....	153
Parameter with index / without direct display.....	155
Parameter without index / without direct display.....	151
Parameters without index / with direct display.....	149
Password entry.....	141
Password heating engineer.....	145
Password OEM.....	146
Program phases.....	127
Reset.....	130
Restore.....	125
Running time.....	127
Safety loop.....	131
Safety notes.....	117
Service level.....	138
Service level display.....	138
Service level end.....	139
Service values.....	139
Special functions.....	120
Standby mode.....	127
Start prevention.....	131
Startup / shutdown.....	127
Startups.....	136
Startups total.....	137
Symbols.....	119
Timeout menu operation.....	122

C

Commissioning notes	
Fuel-air ratio control.....	15

D

Digital input	
Setting time pressure switch.....	42
X3-02.....	38
X3-03 pin 1 / 2.....	37
X3-04 pin 1 / 2.....	36
X5-01.....	40
X5-02.....	43
X5-03 pin 1.....	37
X5-03 pin 2 / 3.....	37
X8-04 pin 1.....	44
X9-04.....	39
Digital outputs	
X3-05 pin 1.....	45
X3-05 pin 2.....	45
X3-05 pin 3.....	45
X4-02.....	46
X6-03.....	47

X8-02 / X7-01	47	Traveling speed	89, 95
X8-04 pin 2	47	Traveling speed / curve slope	92
Dimensions	32	I	
Display / diagnostics	33	Inputs / outputs	
E		X10-05 / X10-06	33
Error code list	193	Ionization probe	
Error history	115	Technical data	26
Error classes	115	L	
Makeup	116	Lifecycle function	117
F		LMV27	33
Flame detector		Commissioning notes	15
Electrical connection	14	Connection / internal diagram	111
Flame detectors		Digital input	36
Extraneous light	35	Digital outputs	45
Flame intensity	35	Dimensions	32
Loss of flame	34	Electrical connection	12
No flame end of TSA	35	Europe	20
Supervision	35	Flame detectors	34
Fuel meter configuration		General information	21
Fuel meter types	109	Inputs / outputs	33
Meter readings	109	Program sequence	48
Pulses configuration	109	Sequence diagrams	71
Fuel meter input X75 pin 1 / 75 pin 2	2109	System structure	20
Fuel meter configuration	109	Technical data	22
Fuel throughput	110	Type summary	21
Fuel throughput		Load controller	82
Configuration	110	Load sources	87
Reading out	110	Manual output	86
Fuel trains		Output with curve settings	86
Gas direct ignition	63	X5-03 pin 1	82
Gas direct ignition 1	63	X5-03 pin 2 / 3	82
Gas direct ignition 2	63	X92	85
Light oil direct ignition, modulating	67	Load controller sources	
Light oil direct ignition, modulating with 2 fuel valves	68	Emergency operation	87
Light oil direct ignition, multistage	65	Load output	
Fuel-air ratio control	89	2-stage operation	108
Curves	95	3-stage operation	108
Definition curves	91	Modulating operation	108
General	89	Load output X74 pin 3	107
Home position	89	Safe separation voltage	107
Ignition	90	Load sources	
Minimum / maximum output	94	Manual control	87
Modulating operation	91	M	
Modulation range	93	Mounting notes	10
Modulation range limitation	97	O	
Multistage operation	95	Operating mode	79
Operating position	92, 96	Deleting curves	81
Operating position end	97	P	
Operating positions	89	Parameter list	181
Outputs	96	Program sequence	
Postpurging	90	Fuel trains	63
Prepurging	89	Special functions	53
Running position	92	Time parameters	48
Settings / parameter settings	97	Valve proving	49

Q		Lo / Lo mod / Lo 2-stage / Lo 3-stage	74
QRA		Special features	112
	Technical data		28
QRB		Special functions	
	Technical data	Alarm / start prevention	54
		Continuous fan	60
QRB4		Forced intermittent operation ..	59
	Technical data	Gas shortage program	58
QRC		Low-fire shutdown	59
	Technical data	Program stop function	59
R		Repetition counter	55
Reference		Reset / manual lockout	53
	Travel	Start preventions	54
		Start without prepurging	57
S		Test function TÜV	61
Safety notes		Superposed system	112
	Commissioning notes	Information / Functions	112
	Connection BCI via RJ11 jack ..	Modbus	113
	Disposal notes		
	Installation notes	T	
	Life cycle	Technical data	22
	Mounting notes	Cable lengths	24
	Service notes	Cross-sectional areas	24
	Settings / parameter settings ...	Environmental conditions	25
	Standards / certificates	Flame detectors	26
	Warning notes	Terminal loading inputs	22
Safety notes:		Terminal loading outputs	23
Sequence diagrams		X74 pin 3	23
	LoGp, LoGp mod, LoGp 2-stage		
	V	
		Valve proving	
Sequence diagrams		Phase 00	51
	G / G mod / G mod pneu	Phase 01	52
		X5-01	51
	Gp1 / Gp1 mod / Gp1 mod pneu	X9-04	50
	Gp2 / Gp2 mod / Gp2 mod pneu		

30 List of figures

Figure 1: Note on mounting	10
Figure 2: Electrical connection	12
Figure 3: Connection of OCI410 interface to the BCI	13
Figure 4: System structure	20
Figure 5: Ionization input at AC 230 V	27
Figure 6: Measuring circuit for ionization probe	27
Figure 7: Measuring circuit QRA	28
Figure 8: QRB1/QRB3 input at AC 230 V	29
Figure 9: Measuring circuit QRC	31
Figure 10: Dimensions of the LMV27	32
Figure 11: Flame signal input X10-05	33
Figure 12: Flame signal input X10-06	33
Figure 13: Safety loop X3-04	36
Figure 14: Burner flange X3-03	37
Figure 15: Inputs for external load controller ON / OFF X5-03	37
Figure 16: Inputs external load controller Open / Close X5-03	37
Figure 17: Air pressure switch X3-02	38
Figure 18: Gas pressure switch valve proving X9-04	39
Figure 19: Gas pressure switch-min / oil pressure-min X5-01	40
Figure 20: Gas pressure-max / oil pressure switch-max or POC X5-02	43
Figure 21: Reset X8-04	44
Figure 22: Output alarm X3-05	45
Figure 23: Fan motor contactor X3-05	45
Figure 24: Continuous fan operation X3-05	45
Figure 25: Output ignition X4-02	46
Figure 26: Output fuel valve V1 X8-02	47
Figure 27: Output fuel valve V2 X7-01	47
Figure 28: Output fuel valve V3 / pilot valve X7-02	47
Figure 29: Output safety valve X6-03	47
Figure 30: Output for indication of operation X8-04	47
Figure 31: Without manual locking	53
Figure 32: With manual locking	53
Figure 33: Message in the case of program stop	59
Figure 34: Continuous fan	60
Figure 35: Application example of postpurging in the lockout position with fan but without VSD	62

Figure 36: Gas direct ignition	63
Figure 37: Gas pilot ignition 1	63
Figure 38: Gas pilot ignition 2	63
Figure 39: Gas trains – fuel valve control	64
Figure 40: Light oil - direct ignition 1-stage	65
Figure 41: Light oil - direct ignition 2-stage	65
Figure 42: Light oil - direct ignition 3-stage	65
Figure 43: Light oil - direct ignition stage - fuel valve control	66
Figure 44: Light oil - direct ignition modulation	67
Figure 45: Light oil - direct ignition modulation	67
Figure 46: Light oil - direct ignition - fuel valve control	67
Figure 47: Light oil – direct ignition, modulating, without shutdown facility for adjustable head	68
Figure 48: Light oil – direct ignition, modulating, with shutdown facility for adjustable head	68
Figure 49: Light oil - direct ignition - fuel valve control	68
<i>Figure 50: Light oil with gas pilot ignition</i>	<i>69</i>
<i>Figure 51: Light oil with gas pilot ignition – fuel valve control</i>	<i>69</i>
<i>Figure 52: Light oil with gas pilot ignition</i>	<i>70</i>
<i>Figure 53: Light oil with gas pilot ignition – fuel valve control</i>	<i>70</i>
Figure 54: Program for gas direct ignition (G)/(G mod)/(G mod pneu)	71
Figure 55: Program for gas pilot ignition (Gp1)/(Gp1 mod)/(Gp1 mod pneu)	72
Figure 56: Program for gas pilot ignition (Gp2)/(Gp2 mod)/(Gp2 mod pneu)	73
Figure 57: Program for light oil direct ignition (Lo)/(Lo mod)/(Lo 2-stage)/(Lo 3-stage)	74
Figure 58: Program light oil – pilot ignition «LoGp» «LoGp mod» «LoGp 2-stage»	75
Figure 59: Modulating operation X5-03	82
Figure 60: 2-stage operation X5-03	83
Figure 61: 3-stage operation X5-03	83
Figure 62: Shifting multistage operation (OPEN pin 3 / CLOSE pin 2)	84
Figure 63: Definition of curves	91
Figure 64: Restriction of modulation range	93
Figure 65: Adjustment of output	96
Figure 66: Fuel actuator (X54)	98
Figure 67: Air actuator (X53)	98
Figure 68: Angle definitions with SQM33	102
Figure 69: Direction of rotation (example SQM3)	103
Figure 70: Power output	107
Figure 71: Fuel meter input X75	109

Figure 72: Inputs and outputs	111
Figure 73: Connection via interface COM 92 to superposed systems.....	112
Figure 74: Communication with display / BCI (RJ jack) (X56).....	114
Figure 75: Display input BCI (RJ11 jack) X56	114
Figure 76: Description of unit / display and buttons.....	118
Figure 77: Meaning of display	119
Figure 78: Assignment of levels	132
Figure 79: Info level	133
Figure 80: Service level	138
Figure 81: Parameter level structure	148
Figure 82: Setting the curvepoints.....	166
Figure 83: Changing several curvepoints	173